

COMPACTED ROAD BASE and SUBBASE SOILS

33 Moisture/Density relationship

34 CBR California Bearing Ratio

35 Field density, Bearing capacity

38 Soil permeability

When highway or railway earthworks,

bases, sub-bases and dams are prepared for construction, it is necessary to compact the material mechanically, in order to achieve the necessary high degree of density. In doing so, this procedure increases the shear strength, reduces the permeability and water absorption, and reduces the tendency to settle under repeated loading. Compaction is therefore defined as the process of increasing the density of a material by mechanical means.

To simulate the procedure adopted in the earthworks to obtain a defined level of compaction in the field, several laboratory tests have been developed over the years; differing only by the varying level of energy applied to the soil sample.

The equipment detailed here in Section 33 concerns mainly Proctor moulds and compactors. Section 34 covers the CBR equipment and various models of loading presses, while the equipment presented in Section 35 covers all devices for determining the in-situ density and various models of plate bearing test apparatus.

Finally, Section 38 details the various apparatus for determining the permeability of soil.

Compacted road base and subbase soils

33

Moisture/Density relationship

Proctor moulds and rammers	114
Automatic Proctor/CBR compactors	116
Vibrating compaction hammer	118
Proctor penetrometer	118
Compressive strength	118
Load ring penetrometer	118
Moisture condition apparatus	119
Relative density test sets	119

34

CBR California Bearing Ratio

CBR moulds and accessories	120
Swell test apparatus	123
Field CBR test set	123
CBR specific load frame and presses	124
MULTISPEED loading presses	126
Impact soil tester	130

35

Field density, Bearing capacity

Sand density cone apparatus	131
Balloon density apparatus	132
Surface soil samplers	133
Plate bearing test apparatus	134
Lightweight deflectometer	140

38

Soil Permeability

Constant and falling head apparatus	141
Pinhole test apparatus	143

Proctor moulds and rammers

Used for determining the relationship between the moisture content and density of compacted soil. The moulds include collar, mould body and base plate.

The rammer construction includes a guide sleeve with vent holes. Different versions are available that conform to the various commonly used standards. They are all made of plated steel and are identical in shape, only differing slightly in diameter and capacity. For the extrusion of soil specimens from the mould, the Universal specimen extruder may be used. See Accessories.

An alternative (and preferable) method of compacting is to use an automatic compactor. For more information, see AUTO-PROCTOR, the automatic Proctor-CBR compactor, page 116

Proctor moulds and rammers conforming to EN

STANDARD ▶ EN 13286-2

Moulds

Code	Internal diameter (mm)	Body height (mm)	Approx. weight (kg)
33-T0070/EN	100 ± 1	120 ± 1	5.0
33-T0070/ENS*	100 ± 1	120 ± 1	5.0
33-T0071/EN	150 ± 1	120 ± 1	8.9
33-T0071/ENS*	150 ± 1	120 ± 1	8.9
33-T0074/E	250 ± 1	200 ± 1	32

*Split version

Steel plates

Code	Diameter (mm)	Thickness (mm)	Approx. weight (kg)
33-T0070/E1	99.5	10	0.6
33-T0071/E1	149.5	10	1.3
33-T0074/E1	249.5	20	7.6

Rammers

Code	Rammer diameter (mm)	Free fall height (mm)	Rammer weight (kg)	Approx. weight (kg)
33-T0075/E	50 ± 0.5	305 ± 3	2.49	3.0
33-T0076/E	50 ± 0.5	457 ± 3	4.54	5.3
33-T0077/E*	125 ± 0.5	600 ± 3	15.0	23

Proctor moulds and rammers conforming to ASTM, AASHTO and CNR

STANDARD

▶ ASTM D558, D698, D1557 ▶ AASHTO T99, T134, T180 ▶ CNR N°69

Moulds

Code	Volume (cm ³)	Internal diameter (mm)	Body height (mm)	Approx. weight (kg)
33-T0070/A	944	101.6	116.4	7.0
33-T0071/A	2124	152.4	116.4	9.0
33-T0072/A*	944	101.6	116.4	7.5
33-T0073/A*	2124	152.4	116.4	9.5

*Split versions

Rammers

Code	Rammer diameter (mm)	Free fall height (mm)	Rammer weight (kg)	Approx. weight (kg)
33-T0075	50.8	305.0	2.49	3.0
33-T0076	50.8	457.2	4.54	5.3

Accessories (for all moulds)

16-T0080

Universal extruder

Used to remove 4"(101.6 mm), 6"(152.4 mm), 100 mm and 150 mm diameter specimens from Proctor, CBR and Marshall moulds. Constructed of steel, with adapters that correspond to the diameter of the moulds and can easily be fitted. Capacity: 50 kN, Ram travel: 197 mm (ram) + 68 mm (screw), Weight: 25 kg (approx.)

Proctor moulds and rammers conforming to BS

STANDARD ▶ BS 1377:4, 1924:2

Moulds

Code	Volume (cm ³)	Internal diameter (mm)	Body height (mm)	Approx. weight (kg)
33-T0070/BS	1000	105.0	115.5	7.0

Rammer

Code	Rammer diameter (mm)	Free fall height (mm)	Rammer weight (kg)	Weight (kg)
33-T0075/B	50	300	2.5	3.0
33-T0076/B	50	450	4.5	5.3



Proctor moulds and rammers conforming to NF

STANDARD ▶ NF P94-078, P94-93, P98-231-1

Moulds

Code	Volume (cm ³)	Internal diameter (mm)	Body height (mm)	Approx. weight (kg)
33-T0070/NF	944	101.6	116.4	7.0
33-T0072/NF*	944	101.6	116.4	7.5
33-T0089/NF	2758	152.0	152.0	9.0
33-T0089/NFS*	2758	152.0	152.0	10.0

*Split versions

Rammer

Code	Rammer diameter (mm)	Free fall height (mm)	Rammer weight (kg)	Weight (kg)
33-T0075	50.8	305	2.49	3.0
33-T0076	50.8	457	4.535	5.3

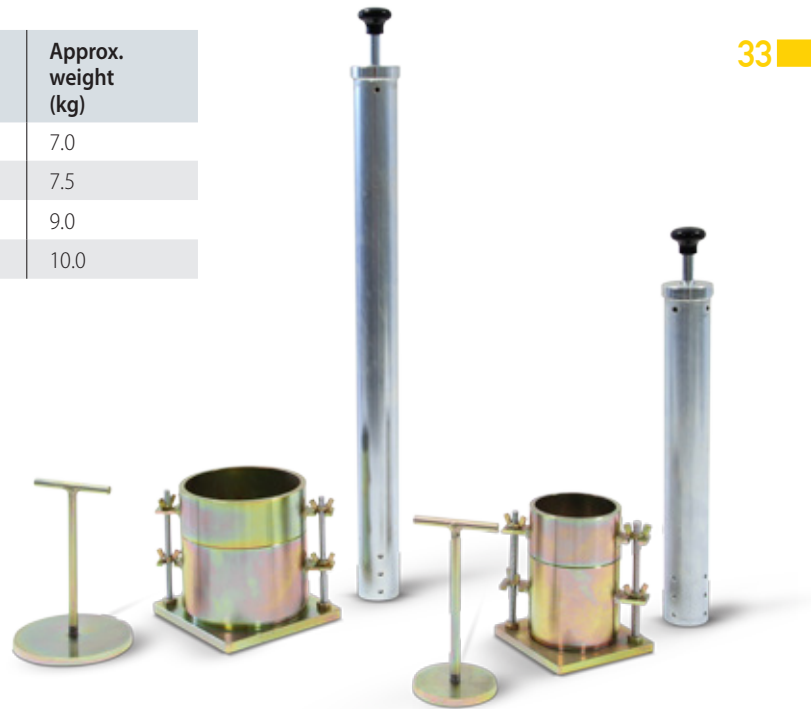

EN compaction equipment

Proctor moulds and rammers conforming to NLT and UNE

STANDARD ▶ NLT-108/91 ▶ UNE 103-500

Moulds

Code	Volume (cm ³)	Internal diameter (mm)	Body height (mm)	Approx. Weight (kg)
33-T0070/C	1000	102.0	122.4	7.0
33-T0070/C3*	1000	102.0	122.4	7.0
33-T0071/C	2320	152.4	127.0	10.0
33-T0071/C3*	2320	152.4	127.0	10.0

*Split versions

Rammer

Code	Rammer diameter (mm)	Free fall height (mm)	Rammer weight (kg)	Weight (kg)
33-T0075	50.8	305	2.49	3.0
33-T0076	50.8	457	4.535	5.3



ASTM Compaction equipment

Multi-Standards Universal Automatic Proctor/CBR Compactor

STANDARD

- ▶ EN 13286-2 ▶ EN 13286-47
- ▶ ASTM D698 ▶ ASTM D1557
- ▶ ASTM D1883 ▶ ASTM D558
- ▶ AASHTO T99 ▶ AASHTO T180
- ▶ AASHTO T193 ▶ BS 1377:4
- ▶ NF P94-093 ▶ NF P94-066
- ▶ UNE 103-500 ▶ AS 1289.5.1.1
- ▶ AS 1289.5.2.1

33

Detail of blow distribution, evidencing the central blow specimens



Mould Ø 150/6"



Mould Ø 100/4"



MAIN FEATURES and ADVANTAGES

- » Universal and fully automatic machine matching all Standards EN, ASTM, AASHTO, AS, BS, NF, and others, including central stroke
- » Immediate software setting of the reference Standard
- » Tailored compaction cycles programmable by the user
- » Continuous monitoring of the dropping height during compaction and automatic real time adjustment assuring high precision throughout the whole compacting path
- » Dropping height precision better than Standards' prescription from the beginning to the end of the compacting path
- » Automatic dropping high set by controller avoiding manual adjustment
- » Robust long-lasting transmission suitable for intensive use
- » 30 strokes / min
- » Safety guards and emergency stop button included
- » Total accessibility to the test area by double door system also including transparent panels
- » Compatible with mould dia. 100 to 152.4 mm (4" and 6")
- » Universal impact rammer including circular dia. 50 mm and 2"
- » Upgrading kit for Australian Standards available (see accessories)
- » Quick and easy rammer swap and weight adjustment
- » Noise reduction cabinet

CONTROLS Proctor/CBR universal compactor performs fully automatic, accurate, programmable and uniform compaction cycles providing repeatable test results and preventing human errors. Conforming to EN, ASTM, AASHTO, AS, BS, NF (and others), designed for moulds 100 mm - 4" and 150 mm - 6", the 33-T3700 Series features:

Superior accuracy

The machine continuously measures and adjusts the dropping height at each stroke during compaction assuring uniquely high precision throughout the whole compacting path. The rammer holding mechanism is based on a robust transmission assuring long-durability also in case of intensive use.

Optimal user interface

The machine adopts a user-friendly HMI based on high-resolution colour graphical display 128x80 pixels and membrane keyboard. Test procedures are pre-stored according all the reference Standards and it is also possible to program user-defined tailored procedures.

Total functionality

The machine is supplied with universal impact rammer including circular dia. 50 mm and 2". Furthermore, rammer swap and weight adjustment in accordance with international Standards (see Table) is quick and easy.

An upgrading kit for Australian Standards is also available on request (see accessories).

Dropping height is set from the digital display replacing any impractical manual adjustment. The mould fixing system, adopting a quick release clamping mechanism, is extremely flexible resulting compatible with both, CONTROLS and other made CBR/Proctor moulds (please ask our sales department for verification).

Standards	Rammer face dia.	Rammer weight	Rammer dropping height
ASTM D698	50,8 mm	2,49 kg	304,8 mm
ASTM D558	50,8 mm	2,49 kg	304,8 mm
ASTM D1557	50,8 mm	4,54 kg	457,2 mm
ASTM D1883	50,8 mm	2,49 kg 4,54 kg	304,8 mm 457,2 mm
AASHTO T99	50,8 mm	2,49 kg	305 mm
AASHTO T180	50,8 mm	4,54 kg	457 mm
AASHTO T193	50,8 mm	2,49 kg 4,54 kg	305 mm 457 mm
EN 13286-2 EN 13286-47 NF P94-093	50 mm	2,50 kg 4,50 kg	305 mm 457 mm
BS 1377-4	50 mm	2,50 kg 4,50 kg	300 mm 450 mm
AS 1289.5.1.1	50 mm	2,7 kg	300 mm
AS 1289.5.2.1	50 mm	4,90 kg	450 mm

Ergonomic and safe

The machine features a double door system including transparent panels ensuring comfortable access to the test area and providing free view of the chamber during compaction. Safety switches stop the machine when doors are open, and an emergency stop button is mounted on the control panel. Altogether, safe operation conforming to the CE directives is assured. A noise reduction cabinet is available on request. It is manufactured from steel sheet and lined internally with soundproofing material. If necessary, the control panel can be easily removed and mounted externally. Furthermore, this soundproofing cabinet is designed to keep the operator access fully comfortable by double top-and-front opening system.



Detail of the quick release clamping mechanism for the mould

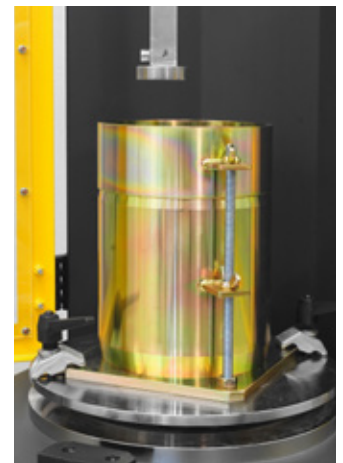

Double door system with transparent panels for easy access to the wide test area

Models	33-T3712, 33-T3713, 33-T3714
Mould/specimen dia.	100 to 152.4 mm (4" and 6")
Rammer faces (interchangeable conforming to Standards, see table)	Circular dia. 50 mm and 2"
Rammer weight (interchangeable conforming to Standards, see table)	2.49, 2.50, 2,70* kg 4.50, 4.54, 4,70* kg
Rammer dropping height (digitally set conforming to Standards, see table)	300, 305, 450, 457 mm
Blow rate	30 strokes / min
Safety features	Compliant with CE directives
Power rating	650 W approx.
Overall dimensions (wxdxh)	494 x 595 x 2378 mm
Weight approx.	150 kg

Ordering information

33-T3712

Universal Fully Automatic programmable Proctor/CBR compactor for specimens from 100 mm - 4" to 150 mm - 6" mm diameter, conforming to EN, ASTM, AASHTO, BS, NF, AS and major international Standards. Universal rammer kit included. 230 V, 50 Hz, 1 ph

33-T3713

Same as above but 220 V, 60 Hz, 1 ph

33-T3714

Same as above but 110 V, 60 Hz, 1 ph

Accessories

33-T3712/AU

Upgrading kit for Australian Standard AS 1289.5.1.1 and AS 1289.5.2.1

33-T3712/CB

Noise reduction cabinet for CBR-Proctor universal compactor

ASTM-AASHTO Automatic Proctor/CBR Compactor

Beside the multi-Standards Proctor/CBR Universal Automatic Compactor, it is also available a simpler but always automatic model specifically conforming to ASTM-AASHTO which do not require a central impact. More details and full ordering information about this model can be found in the CONTROLS Group website.

*using upgrade kit 33-T3712/AU

Vibration compaction hammer

STANDARD

- ▶ EN12697-9 ▶ EN 12697-10
- ▶ EN12697-32 ▶ EN 13286-4
- ▶ BS 1377:4 ▶ BS 1924:2

Used for the compaction of Proctor and CBR soil specimens. using the appropriate tamping foot it can also be used for compacting asphalt in the "Percentage refusal density test". See Vibrating hammer for PRD specimens.

The hammer is supplied without support frame and tampers which have to be ordered separately. See accessories.

- Overall dimensions (wxdxh): 130x530x380 mm
- Weight approx.: 6.8 kg

Ordering information

33-T8702/A

Vibrating hammer. 220-240 V, 50-60 Hz, 1 ph

33-T8702/AZ

Same as above but 110 V, 60 Hz, 1 ph

Accessories

33-T8702/FR

Supporting frame for vibrating hammer.

- Weight: 26 kg approx.

33-T8702/W

Extra weight, 20 kg total, for steel frame model 33-T8702/FR

33-T0087/6

Small tamping foot, 102 mm dia., head only

33-T0087/7

Large tamping foot, 146 mm dia., head only

33-T0087/8A

Shank, 300 mm long



33-T8702/A with 33-T8702/FR, 33-T0087/6, 33-T0087/7 and mould

indicates the maximum pressure obtained in the test.

Supplied in a wooden carrying case.

- Load scale: 0 to 55 kg , 1 kg subdivisions with max load indicator
- Diameter of interchangeable needles: 28.55, 24.79, 20.22, 16.54, 12.83, 9.07, 6.40, 5.23 and 4.52 mm
- Weight approx.: 3.5 kg

33-T0166

LOAD RING PENETROMETER



Used for measuring the bearing strength and compaction degree of soils. The apparatus consists of a "T" shaped handle connected to a load ring 1 kN (100 kgf) cap., with max load pointer, and an extension rod with five 100 mm graduations. The 30° end cone has an area of 645 mm² (1 sq. in). Supplied complete with calibration chart.

- Weight approx.: 4 kg

33-T0165

COMPACTION PENETROMETER

STANDARD

- ▶ ASTM D1558

Used for establishing the moisture content-penetration resistance relationship of fine-grained soils.

It consists of a special spring dynamometer with pressure indicating scale on the stem of the handle. A sliding ring on the stem



33-T0165

Compressive strength of Unbound and Hydraulically bound mixtures

STANDARD

- ▶ EN 12390-4 ▶ EN 13286-41



This multipurpose compression tester can be used for applying static compaction to CBR samples or for 10% Fines/ACV on aggregates.

For more information see page 294

Ordering information

50-C92P02

PILOT Pro Automatic COMPACT-Line compression tester, 600 kN capacity, load measurement by pressure transducer. 230 V, 50-60 Hz, 1 ph.

50-C92P04

As above but 110 V, 60 Hz, 1 ph.

Determination of compactability

Moisture Condition Value (MCV) and Chalk Crushing Value (CCV)

STANDARD

▶ EN 13286-46 ▶ BS 1377:4

Manufactured under license from TRL-UK

33-T0064 MOISTURE CONDITION APPARATUS

Used in the assessment of earthworks for construction by comparing compaction characteristics at various moisture contents in order to determine the "Moisture Condition Value" and "Chalk Crushing Value." This robust apparatus is designed for use in the construction laboratory and incorporates a rammer, scale, counter, and mould.

Weight: 55 kg (approx.)

Accessories

33-T0064/1

Moisture condition mould

33-T0064/2

Fibre discs, pack of 6.

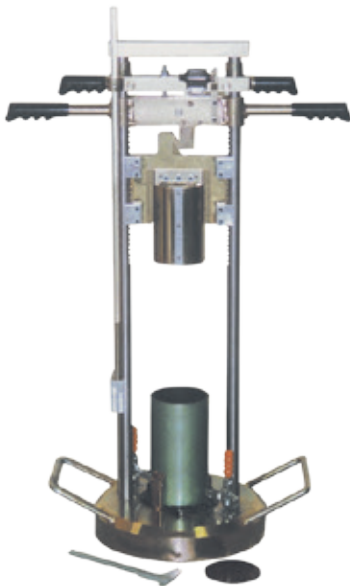

Relative density of cohesionless soil

STANDARD

▶ EN 13286-5 ▶ ASTM D4253

▶ ASTM D4254

This method, in the EN standard, covers the determination of the maximum dry density and water content of cohesionless materials when compacted using a vibrating table. Materials for which this method is applicable may contain up to 12% fines (<0.063 mm) by mass. The maximum particle size of the material to be tested is 80 mm. This method applies to mixtures to be used in road construction.

The ASTM also specifies that the method is used for the determination of the relative density of cohesionless soil for which impact compaction will not produce a well-defined moisture/density relationship curve and where the maximum density of the impact method will generally be less than by the vibratory method.

Two versions of test set are available: 33-T0063/A conforming to EN and 33-T0063 conforming to ASTM. They are practically identical except for the 0.1 ft³ mould which is also included with 33-T0063.



Specifications

Both 33-T0063/A (EN) and 33-T0063 (ASTM) test sets include:

- **33-T0063/3:** 14200 cm³ (0.5 ft³) mould set
- **33-T0063/4:** Relative density gauge set
- **33-T0063/1:** Vibrating table (33-T0063/1 Y for 220 V, 60 Hz or 33-T0063/1 Z for 110 V, 60 Hz) with the following specifications:
 - Vibration frequency: 3600 rpm.
 - Amplitude range: 0.05 to 0.64 mm
 - Vibrator type: electromagnetic
 - Separate amplitude control panel
 - Table dimensions: 762 x 762 mm
 - Table capacity: 250 kg

The 33-T0063 ASTM version also includes:

33-T0063/2

0.1 cu. Ft. relative density mould set (cylinder with lead, cylinder in cast aluminum, disc with handle and upper cylinder).

-Overall weights approx.:

33-T0063/A: 289 kg

33-T0063: 310 kg

Note: each part can be ordered individually

Ordering information

33-T0063/A

EN Relative density test set. 230 V, 50 Hz, 1 ph.

33-T0063

ASTM Relative density test set. 230 V, 50 Hz, 1 ph.

33-T0063/Y

As above but 220 V, 60 Hz, 1 ph.

33-T0063/Z

As above but 110 V, 60 Hz, 1 ph.

Accessories

33-T0063/7

12.5 and 25 mm diameter pouring devices.



CBR (California Bearing Ratio), IBI (Immediate Bearing Index)

This method is used for the laboratory evaluation of subgrade and subbase coarse materials in road construction. The apparatus comprises moulds with accessories, compaction rammers (the automatic models are the same as those used for the compaction of Proctor moulds - see page 116), load testing machines with accessories, etc. Different models are available that conform to the various relevant specifications. Please note that often, some of the items (e.g. Swell plate, Tripod etc.) are common to more than one standard test set.

34

ASTM, AASHTO, UNE, UNI CBR EQUIPMENT

STANDARD ▶ ASTM D1883 ▶ AASHTO T193 ▶ UNE 103-502 ▶ CNR UNI 10009

Ordering information and specifications

Code	Description	Specifications	Approx. weight, kg
34-T0090/A	CBR mould	With collar and perforated base plate - Plated steel. 6" (152.4 mm) diameter, - 7" (177.8 mm) body height	7.8
34-T0090/A1	Split CBR mould	Same as T0090/A, split longitudinally on one side	8.5
34-T0090/3	Filter screen	Stainless steel woven mesh, No.100 (150 µm), 144 mm diameter	0.05
33-T0076	Compaction rammer	2" (50.8 mm) diameter rammer face, 457.2 mm fall, 4.54 kg weight	5.3
33-T0096	Sliding weight rammer (as alternative to 33-T0076)	2" (50.8 mm) diameter rammer face, 457.2 mm fall, 4.54 kg weight	8
34-T0091	Spacer disc with "T" handle	5 ¹⁵ / ₁₆ " (150.8 mm) diameter x 2.416" (61.4 mm) high. Plated steel	7.5
34-T0091/1	UNE Spacer disc	Plated steel	7.5
34-T0094	Annular surcharge	Plated steel, 2.27 kg	2.27
34-T0095	Slotted surcharge	Plated steel, 2.27 kg	2.27
34-T0098	Cutting edge	Plated steel	0.5
34-T0099	Straight edge	3 x 30 x 300 mm	0.3
34-T0097/A	Solid CBR base	Plated steel	1.0
86-D1800	Filter paper	No.1 x 150 mm diameter. Pack of 100	0.3
34-T0092	Swell plate	With adjustable stem	1.0
34-T0093	Gauge tripod	Non-corrodible alloy	0.3
82-D1255	Dial gauge	10 mm travel, 0.01 mm divisions	0.1
16-T0080	Universal extruder	For 100 to 152.4 mm diameter samples	25
34-T0100/B	Soaking tank	Plastic, 680 x 490 x 540 mm (internal dimensions)	9.1

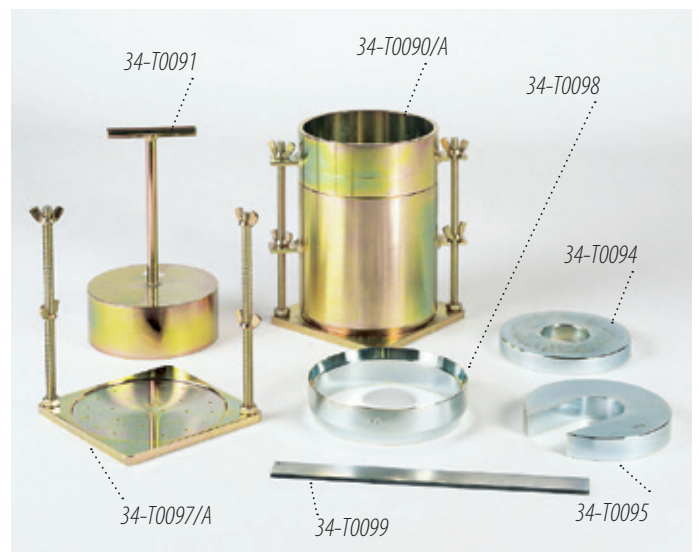

ASTM, AASHTO, UNE, CNR test set (partial)



BS CBR EQUIPMENT

STANDARD ▶ BS 1377:4 ▶ BS 1924:2

Ordering information and specifications

Code	Description	Specifications	Ap- prox. weight, kg
34-T0090/BS1	CBR mould body	Plated steel with both ends threaded to fit the base or collar. 152 mm internal diameter x 127 mm high	3.0
34-T0090/BS2	Extension collar	152 mm internal diameter x 50 mm high	1.0
34-T0090/BS3	Perforated base plate	Plated steel	1.8
34-T0090/BS4	Solid base/top plate	Plated steel	1.8
34-T0090/BS5	Cutting collar	Plated steel	1.0
34-T0090/B6	"C" spanner	To tighten / loosen the collar from the mould body. Two required	1.0
34-T0090/B7	Tool for base plate	To tighten / loosen the solid or perforated base plate from the mould	1.0
34-T0091/B	Compaction plug with handle	150 mm diameter x 50 mm high	7.2
33-T0076/B	Compaction rammer	50 mm diameter rammer face, 450 mm fall, 4.5 kg weight	5.3
34-T0094/B	Annular weight	Plated steel, 2 kg	2.0
34-T0095/B	Split weight	Plated steel, 2 kg	2.0
34-T0095/C	Tamping bar	12.7 mm dia. x 380 mm long	0.4
34-T0099	Straight edge	3 x 30 x 300 mm	0.3
82-D1694	Steel rule	500 mm long	0.1
86-D1800	Filter paper	No.1 x 150 mm diameter. Pack of 100	0.3
34-T0092	Swell plate	With adjustable stem	1.0
34-T0093	Gauge tripod	Non-corrodible alloy	0.3
82-D1255	Dial gauge	10 mm travel, 0.01 mm divisions	0.1
82-D1257 as alt. to D1255	Dial gauge	30 mm travel, 0.01 mm divisions	0.1
16-T0080	Universal extruder	For 100 to 152.4 mm diameter samples	25
34-T0100/B	Soaking tank	Plastic, 680 x 490 x 540 mm (internal dimensions)	9.1

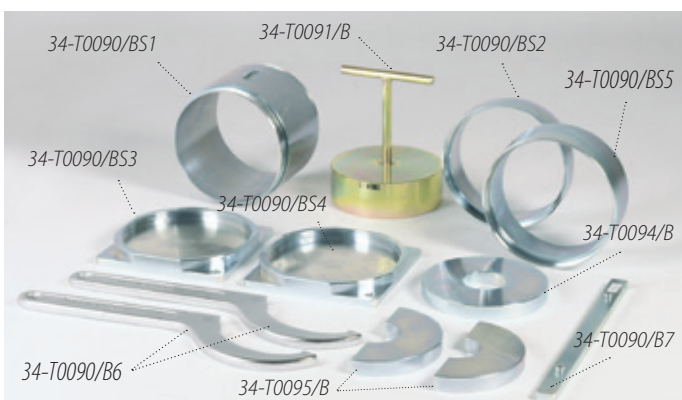

BS test set (partial)

NF CBR EQUIPMENT

STANDARD ▶ NF P94-078 ▶ NF P94-093 ▶ NF P98-231-1

Ordering information and specifications

Code	Description	Specifications	Ap- prox. weight, kg
34-T0089/NF	NF CBR mould	Complete with collar and perforated base plate. Plated steel. 152 mm diameter x 152 mm body height	9.0
34-T0089/NFS	Split NF CBR mould	Same as T0089/NF, split longitudinally on one side	9.0
34-T0076/F	Modified compaction hammer	51 mm diameter rammer face, 457.2 mm fall, 4.54 kg weight	5.3
86-D1800	Filter paper	No.1 x 150 mm diameter. Pack of 100	0.3
34-T0091/F	Spacer disc	Plated steel, 25.4 mm high	3.8
34-T0091/1	Spacer disc	Plated steel, 36 mm high	5.3
34-T0094/F	Annular surcharge weight	Plated steel, 2.3 kg	2.3
34-T0095/F	Split surcharge weight	Plated steel, 2.3 kg	2.3
34-T0098	Cutting edge	Plated steel	0.5
34-T0099	Straight edge	3 x 30 x 300 mm	0.3
34-T0092/F	Swell plate	Plastic with 3 mm diameter holes	0.3
82-D1255	Dial gauge	10 mm travel, 0.01 mm divisions	0.1
82-D1257 as alt. to D1255	Dial gauge	30 mm travel, 0.01 mm divisions	0.1
34-T0093	Gauge tripod	Non-corrodible alloy	0.3
34-T0100/B	Soaking tank	Plastic, 680 x 490 x 540 mm (internal dimensions)	9.1
16-T0080	Universal extruder	For 100 to 152.4 mm diameter samples	25

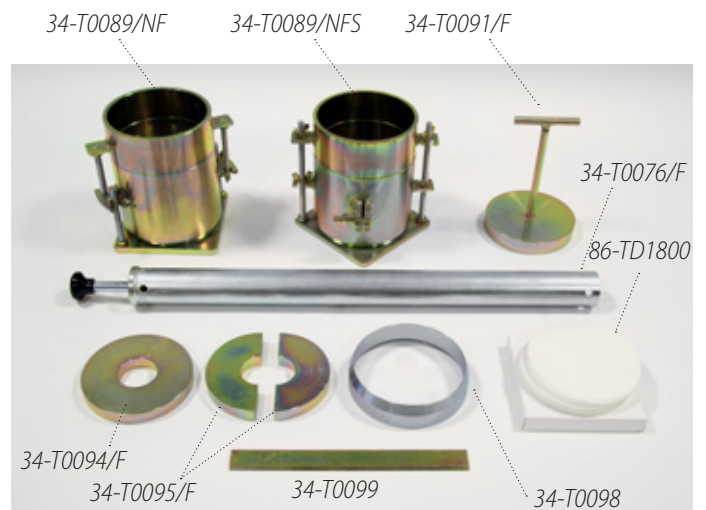

NF test set (partial)

EN CBR EQUIPMENT

STANDARD ▶ EN 13286-47

34

Ordering information and specifications

Code	Description	Specifications	Approx.weight, kg
33-T0071/EN	Proctor/CBR mould	With collar and solid base plate. Plated steel. 150 mm diameter, 120 mm height	8.9
33-T0071/ENS	Proctor/CBR mould split version	With collar and solid base plate. Plated steel. 150 mm diameter, 120 mm height	8.9
33-T071/EB1	Perforated base plate	Plated steel	1.0
34-T0090/3	Filter screen	Stainless steel woven mesh, No.100 (150 µm), 144 mm diameter	0.05
33-T0076/E	Compaction rammer	50 mm diameter rammer face, 457 mm fall, 4.50 kg weight	5.3
34-T0091/E	Spacer disc with "T" handle	149.5 mm diameter, 36 mm high. Plated steel	5.0
34-T0094/B	Annular surcharge	Plated steel, 2 kg	2.0
34-T0095/B	Split surcharge	Plated steel, 2 kg	2.0
34-T0099	Straight edge	3 x 30 x 300 mm	0.3
86-D1800	Filter paper	No.1 x 150 mm diameter. Pack of 100	0.3
34-T0092/E	Swell plate	Aluminum perforated with adjustable stem	1.0
34-T0093	Gauge tripod	Non-corrodible alloy	0.3
82-D1255	Dial gauge	10 mm travel, 0.01 mm divisions	0.1
82-D1257 <i>as alt. to D1255</i>	Dial gauge	30 mm travel, 0.01 mm divisions	0.1
16-T0080	Universal extruder	For 100 to 152.4 mm diameter samples	25
34-T0100/B	Soaking tank	Plastic, 680 x 490 x 540 mm (internal dimensions)	9.1
33-T0077/E	Proctor Hammer	High energy, 15 kg falling weight	15

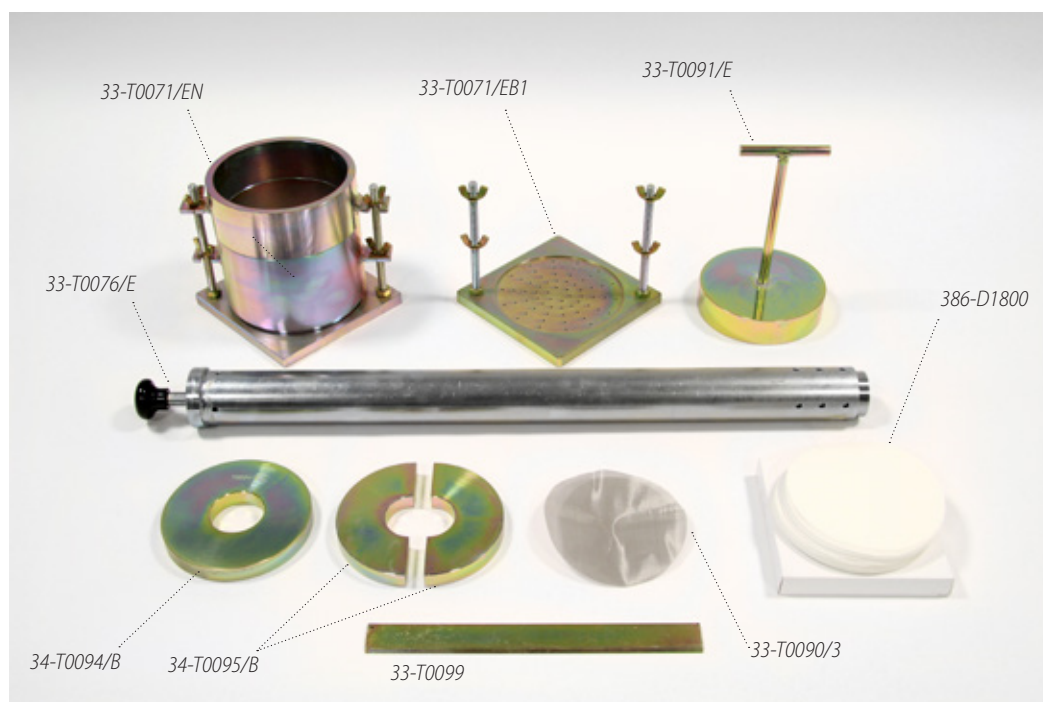

EXPANSION (SWELL) TEST APPARATUS

**34-T0093
DIAL GAUGE TRIPOD**

Used to support the dial gauge for monitoring the swelling of CBR samples. Made from a special non-corrodible alloy. Weight: 0.3 kg (approx.)

82-D1255
Dial gauge, 10 x 0.01 mm
as alternative:

82-D1257
Dial gauge, 30 x 0.01 mm

34-T0092 (T0092/E) with Tripod 34-T0093 and Dial gauge 82-D1257



34-T0092
ASTM Perforated plate with adjustable stem (Swell plate) . Plated steel.
-Weight: 1 kg approx.

34-T0092/F
NF Perforated plate with adjustable stem (Swell plate). Plastic.
-Weight: 0.3 kg approx.

34-T0092/E
EN Perforated plate with adjustable stem (Swell plate) . Aluminum.
-Weight: 0.3 kg approx.



34-T0092/F

**34-T0100/B
LARGE SOAKING TANK**

The CBR moulds are immersed in this plastic water tank during the swelling test. Supplied complete with supporting base, which allows free water circulation.

Capacity: 6 CBR moulds
Dimensions:
External: 800 x 600 x 550 mm;
Internal: 680 x 490 x 540mm;
Weight: 9.1 kg (approx.)



Extruder 16-T0080. Detailed information on page



34-T0100/B with CBR moulds

FIELD CBR APPARATUS

STANDARD
▶ ASTM D4429 ▶ BS 1377:9
▶ BS 1924:2 ▶ UNI 10009

34-T0115/A
Field CBR test set

Used for the in-situ determination of the bearing capacity of soils used in road construction. The complete set is housed in a strong carrying case and includes:

34-T0112*
50 kN capacity mechanical jack.
Weight 8.5 kg.

34-T0112/1*
Ball seating for 34-T0112. Weight 1 kg.
82-T1000/40M*
40 kN capacity load ring. Weight 4 kg.

34-T0103/1*
Adjustable CBR penetration piston.
Weight 2.2 kg.

34-T0104/7*
Adjustable dial gauge holder.

34-T0115/3
Set of 3 extension rods and adapters.
Weight 33 kg.

34-T0115/41
Datum bar assembly including two tripod stands and a 1220 mm long aluminum bar. Weight 7 kg.

82-D1257*
Penetration dial gauge, 30 mm travel, 0.01 mm divisions.

34-T0115/5
9 kg slotted surcharge weight.

34-T0115/6
4.5 kg slotted surcharge weight.



34-T0114 with items*

34-T0115/7
4.5 kg annular surcharge weight.

**Items for use with the 34-T0114 to create a hand operated CBR laboratory loading press.*

Total weight: 70 kg (approx.)

Note: all above items can also be purchased individually.

Accessories

34-T0115/9
Vehicle bracket. For fixing loading jack to a vehicle.

34-T0114
Conversion frame to convert the 34-T0115/A test set into a hand operated CBR loading press for laboratory use.
Total weight (including parts identified with the *in the 34-T0115/A set): 55 kg (approx.)

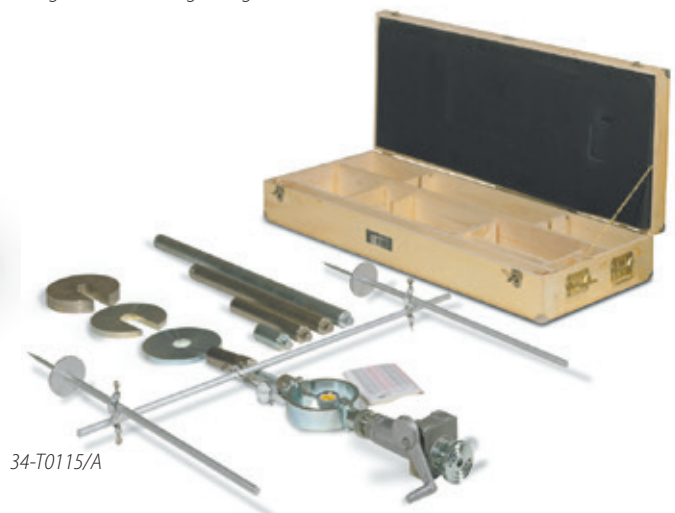

34-T0115/A

CBR (California Bearing Ratio) Penetration test

STANDARD ▶ ASTM D1883 ▶ EN 13286-47 ▶ BS 1377:4 ▶ NF P94-078 ▶ AASHTO T193 ▶ UNI 10009

The CBR penetration test can be performed with a number of loading presses, some of them specifically designed for CBR tests, and others with multiple applications (Universal models-page 126 and 318), at different levels of sophistication. Further details of the product range available is provided below to assist your selection.

34

34-T0102/A

CBR Mechanical loading press, manually/hand operated, 50 kN capacity, complete with 50 kN load ring, penetration piston and dial gauge.



34-T0106/A

CBR Motorized loading press, 50 kN capacity, complete with 50 kN load ring, penetration piston and dial gauge. 230 V, 50 Hz, 1 ph.

- Two column frame with upper crossbeam adjustable in height.
- Test speed: 1.27 mm/min
- Maximum ram travel: 120 mm
- Load ring 50 kN with 0.001 mm div. gauge*
- Dial gauge 30 x 0.01 mm
- Adjustable penetration piston
- Overall dimensions: 392 x 495 x 1194 mm
- Weight approx.: 75 kg

34-T0106

CBR Motorized loading press. Frame only. 230 V, 50 Hz, 1 ph.

To be completed with accessories selected by the user. See page 125

For 110 V, 60 Hz models, add "Z" to the code.

For 220 V, 60 Hz models, add "Y" to the code.

e.g. 34-T0106/AY, 34-T0106/Z

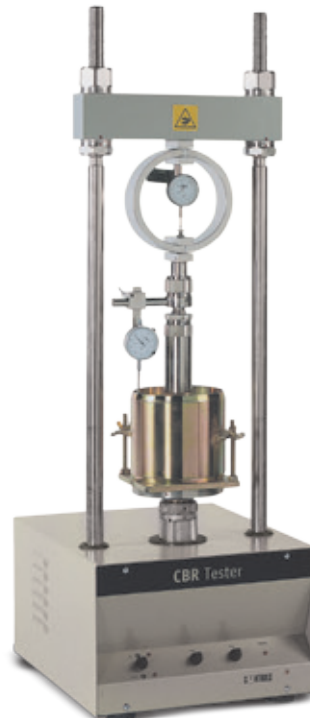

- Two column frame with upper crossbeam adjustable in height.
- Maximum ram travel: 120 mm
- Load ring 50 kN with 0.001 mm div. gauge*
- Dial gauge 30 x 0.01 mm
- Adjustable penetration piston
- Overall dimensions: 300 x 410 x 1140 mm
- Weight approx.: 75 kg

***Important note: All standards prescribe load measurement device (load rings) with minimum resolution obtainable with gauge 0.001 mm divisions. Gauges with 0.01 mm divisions are not accepted.**

CBR ACCESSORIES TO PERFORM THE TEST IN DIGITAL MODE

The 34-T0106 frame can be equipped in digital mode, as shown, with the following accessories:

34-V0107/CBR

Test set to perform the CBR test in digital mode, including:

82-P0375

Load cell, 50 kN capacity

82-P0375/C

Adapter to fit load cell (two pieces)

82-P0322

Displacement transducer, 25 mm travel

34-T0104/81

Adjustable transducer holder

34-T0103/1

Adjustable CBR penetration piston

Also required:

82-P60R02

DIGIMAX TS, Touchscreen, 4-channel readout and processing unit for load and displacement sensors. Suitable for CBR, Marshall, Indirect tensile and general purpose tests. 110-240 V, 50-60 Hz, 1 ph.

82-SW/CMU

PC software for CBR, Marshall, Indirect tensile and general purpose tests.

Note: for more details and information on the DIGIMAX TS and Software, see page 129



34-V0107/CBR complete kit for CBR test, digital configuration



34-T0106 with 34-V0107/CBR and 82-P60R02

MULTISPEED Digital and Automatic universal testers

Suitable for CBR, Marshall*, Indirect tensile*, Unconfined compression*, Quick triaxial* and many other tests.

34

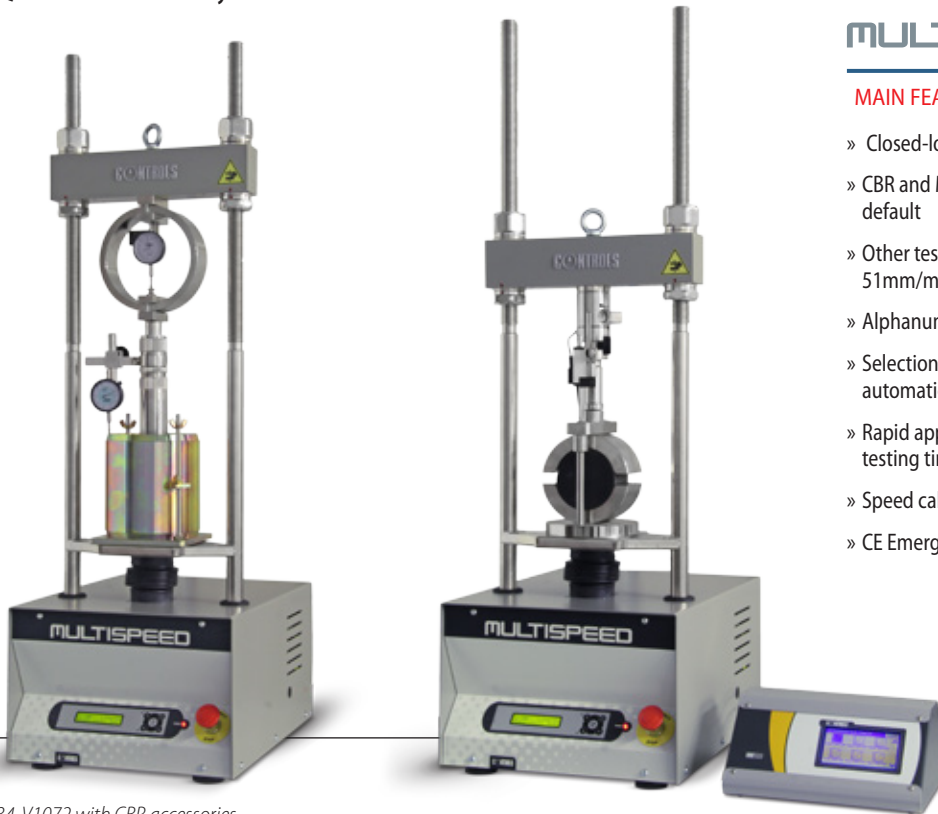

34-V1072 with CBR accessories (analogic)

34-V1072 with Marshall accessories (digital) and Digimax TS 82-P60R02.

MULTISPEED DIGITAL

MAIN FEATURES

- » Closed-loop speed control
- » CBR and MARSHALL test speed can be selected by default
- » Other testing speeds (custom) between 0.2 and 51 mm/min, can be easily set
- » Alphanumeric 2 x16 character display
- » Selection of maximum platen displacement with automatic stop
- » Rapid approach and return function, to reduce the testing time
- » Speed calibration function by firmware
- » CE Emergency stop button

34-V1072 SERIES MULTISPEED DIGITAL VERSION COMPRESSION TESTER

The MULTISPEED compression tester is the ideal solution for Road testing laboratory. The 50 kN capacity and the fully variable test speed of 0.2 to 51 mm/min make it possible to perform not only the CBR and Marshall tests, but many other applications like the Indirect Tensile test, Quick Triaxial tests, Unconfined and Uniaxial soil testing and, in general, all tests to be performed under displacement control. The machine can be equipped with analogical or digital load/displacement measurement systems as well as with the specific accessories, to suit either the field or central laboratory requirement. The various test accessories and relevant Standards, are shown and listed on page 128 and 320

**For the other applications (Marshall, Indirect tensile, etc.), see page 128*

Ordering information

34-V1072

MULTISPEED, digital compression tester, 50 kN capacity, testing speed steplessly adjustable from 0.2 to 51 mm min. 230V, 50-60 Hz, 1 ph

34-V1074

Same as above but 110 V, 60 Hz, 1 ph

CBR accessories

Analogical mode

34-T0103/3

Adjustable penetration piston complete with dial holder and dial gauge 30 x 0.01 mm div.

82-T1000/50M

Load ring 50 kN capacity, fitted with dial gauge 0.001 mm div.

Digital mode

34-V0107/CBR

Test set to perform the CBR test in digital mode, including:

82-P0375

Load cell, 50 kN capacity

82-P0375/C

Adapter to fit load cell (two pieces)

82-P0322

Displacement transducer, 25 mm travel

34-T0104/81

Adjustable transducer holder

34-T0103/1

Adjustable CBR penetration piston

All above items can be ordered individually.

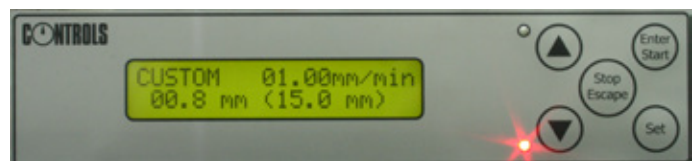
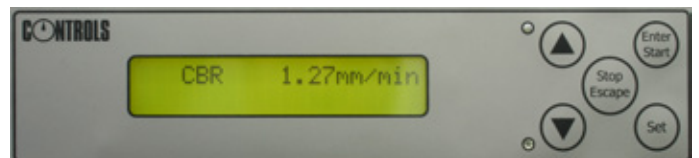

Examples of screenshots

82-SW/CMU

PC software for CBR, Marshall, Indirect tensile and general purpose tests.

Note: The Multispeed 34-V1072 Series also requires data acquisition system. See Digimax TS 82-P60R02 on page 129



MULTISPEED AUTOMATIC

MAIN FEATURES

- » Stand-alone automatic digital load frame 50 kN capacity
- » Closed-loop speed control
- » Four channel on board data acquisition
- » Large touchscreen graphic display: 240 x 128 pixel
- » CBR and MARSHALL test speed can be selected by default
- » Infinitely variable speed from 0.05 to 51 mm/min can be easily set by keyboard
- » Data download: using LAN port (ASCII, TXT or Controls format)
- » USB port for USB memory stick data storage

34

34-V1172 equipped with CBR digital testing accessories

34-V1172 equipped with Marshall digital testing accessories

34-V1172 SERIES MULTISPEED AUTOMATIC VERSION UNIVERSAL TESTER

The 34-V1172 Series MULTISPEED is a versatile stand-alone machine; an ideal solution for road testing laboratories and generally for any test that requires displacement/speed control. The 50kN capacity and fully variable speed of 0.05 to 51 mm/min make it possible to perform not only CBR and Marshall tests, but also many other applications such as indirect tensile, quick undrained triaxial and unconfined/uniaxial soil tests.

No external transducer is required for displacement measurement. The firmware allows performance of transducer calibrations and setting of up to 10 test profiles, saving data onboard. A real-time test graph and transducer data are displayed on the touchscreen. The machine has built-in data acquisition with four channels dedicated to two strain gauge load cells and two potentiometric linear transducers; one of each can be used during the test.

Ordering information

34-V1172

MULTISPEED automatic compression tester, 50 kN capacity, 4 channel built-in data acquisition and variable speed from 0.05 to 51 mm/min. 230V, 50-60Hz, 1 ph

34-V1174

same as above but 110V, 60Hz, 1 ph

Technical specifications

Both machine series 35-V1072 and 35-V1172 features:

- Horizontal clearance (distance between columns): 270 mm
- Maximum vertical clearance (without accessories): 730 mm
- Platen travel: 100mm
- Overall dimensions (l x w x h): 392x495x1213 mm
- Net weight approx.: 65 kg

CBR accessories

Digital mode

34-V0107/CBR

See page 126

82-SW/CMU

PC software for CBR, Marshall, Indirect tensile and general purpose tests.

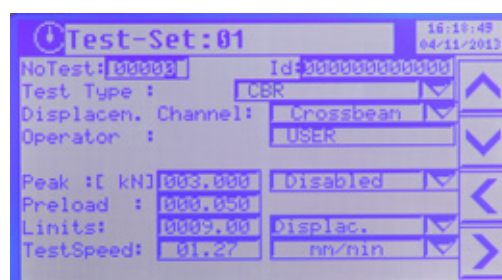
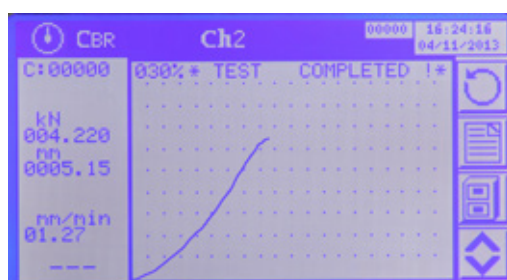
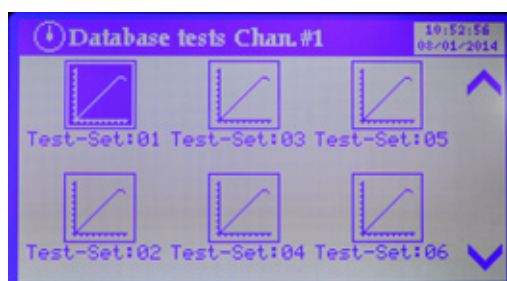

Examples of screenshots

Multispeed accessories for 34-V1072 and 34-V1172 series

To perform MARSHALL test in digital mode conforming to:

STANDARD

- ▶ EN 12697-34* ▶ ASTM D1559
- ▶ ASTM D5581 ▶ ASTM 6927-06
- ▶ AASHTO T245 ▶ BS 598-107
- ▶ NF P98-0251-2 ▶ DIN 1996
- ▶ CNR 30



34-V0107/MAR

Test set to perform the Marshall test in the digital mode, including:

- 82-P0375**
Load cell 50 kN capacity

- 82-P0375/C**
Adapter to fit load cell (two pieces)

- 82-P0322**
Displacement transducer, 25 mm travel

- 34-T0104/81**
Adjustable transducer holder

- 34-T0104/13**
Compression device extension

- 34-T0104/10**
Compression device

- 76-B0033/4**
Stability mould

All above items can be ordered individually.

- 82-SW/CMU**
PC software for CBR, Marshall, Indirect tensile and universal tests. (Optional).

Note: The Multispeed 34-V1072 Series also requires data acquisition system. See Digimax TS 82-P60R02 on next page.

*The EN Standard specifies that Marshall Testers must be used in digital mode with a recording unit.

To perform CBR and MARSHALL tests in digital mode

(To avoid duplications when both tests have to be performed)

- 34-V0107/CM**
Test set for performing CBR and Marshall tests in digital mode, including:

- 82-P0375**
Load cell, 50 kN capacity

- 82-P0375/C**
Adapter to fit load cell (two pieces)

- 82-P0322**
Displacement transducer, 25 mm travel

- 34-T0104/81**
Adjustable transducer holder

- 34-T0103/1**
Adjustable CBR penetration piston

- 34-T0104/13**
Compression device extension

- 34-T0104/10**
Compression device

- 76-B0033/4**
Stability mould 4"

To perform INDIRECT TENSILE tests on bituminous mixtures conforming to:

STANDARD

- ▶ EN 12697-12 ▶ EN 12697-23
- ▶ ASTM D4123 ▶ CNR 34

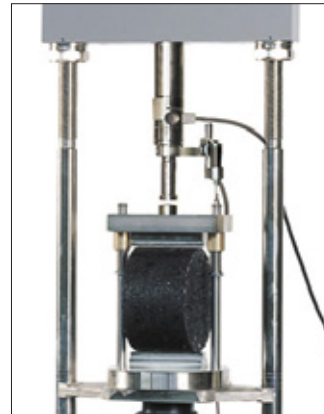

- 82-P0375**
Load cell, 50kN capacity

- 82-P0375/C**
Adapter to fit load cell (two pieces)

- 82-P0322**
Displacement transducer, 25mm travel

- 34-T0104/81**
Adjustable transducer holder

- 34-T0104/13**
Compression device extension

- 34-T0104/10**
Compression device

- 76-B0078/F**
Frame for tensile splitting device. To be completed with suitable pair of loading strips.

- 76-B0078/F1**
Pair of loading strips for 100 mm diameter samples

- 76-B0078/F2**
Pair of loading strips for 150 mm diameter samples

- 82-SW/CMU**
PC software for CBR, Marshall, Indirect tensile and universal tests. (Optional).

Note: The Multispeed 34-V1072 Series also requires data acquisition system. See Digimax TS 82-P60R02 on next page.

To perform UNCONFINED COMPRESSION tests on soil conforming to:

STANDARD

- ▶ EN 12697-12 ▶ EN 12697-23
- ▶ ASTM D4123 ▶ CNR 34



- 82-P0370**
Load cell, 2.5kN capacity

- 82-P0375/C**
Adapter to fit load cell (two pieces)

- 82-P0322**
Displacement transducer, 25mm travel

- 34-T0104/81**
Adjustable transducer holder

- 70-T0108/5**
Load cell extension

- 34-T0104/4**
Platens for unconfined compression

- 82-SW/CMU**
PC software for CBR, Marshall, Indirect tensile and general purpose tests (Optional)

Note: The Multispeed 34-V1072 Series also requires data acquisition system. See Digimax TS 82-P60R02 on next page.



If further tests have to be performed, eg. Unconfined, Quick triaxial, Compression and flexural tests on rock and cement etc, please refer to the web page universal tester accessories.

DIGIMAX TOUCH screen readout and data acquisition unit for CBR, Marshall, Indirect tensile and universal tests

MAIN FEATURES

- » Large size touch screen display 240 x 128 pixel showing numbers and diagrams
- » PC connection via LAN port allowing broader band, better stability and longer distance compared to the RS232 serial communication. Basic software included
- » Unlimited data storage on USB pen drives
- » Total number of channels: 4 in total. 2 channels are dedicated to load sensors and 2 channels are dedicated to displacement transducers. A maximum of 2 channels (1 load and 1 displacement) selected by the user can be simultaneously used
- » Effective sampling rate up to 50 / sec

Ordering information

82-P60R02

DIGIMAX TOUCH- Four channel readout and processing unit for load and displacement sensors, up to two channels can be used simultaneously. Suitable for Marshall, CBR, indirect tensile and general purpose tests. 110-240V, 50-60Hz, 1 ph.

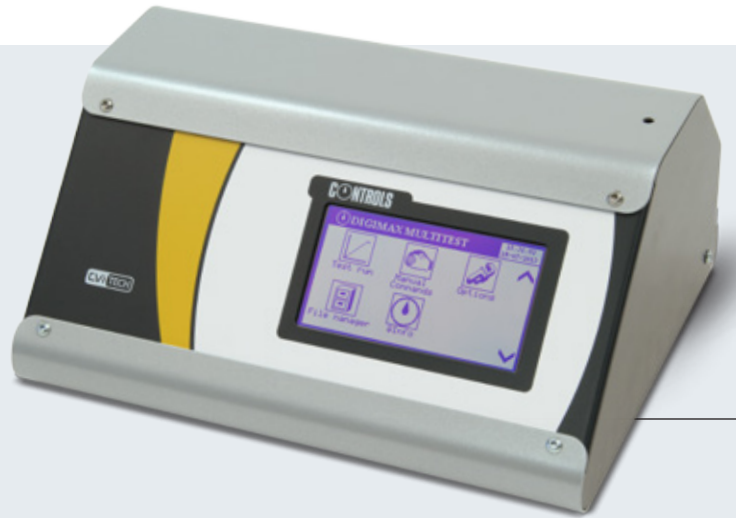

34

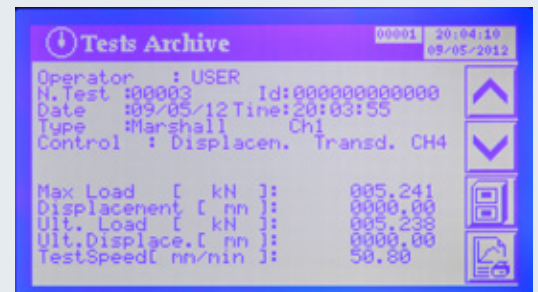
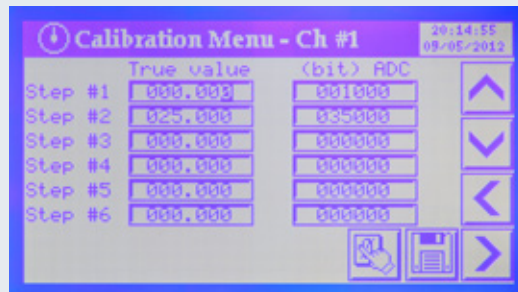

82-SW/CMU

PC software for CBR, Marshall, Indirect tensile and Universal tests

STANDARD

- » EN 12697-34 ▶ ASTM D1883
- » ASTM D1559 ▶ ASTM D5581
- » AASHTO T245 ▶ EN 12697-12
- » BS 1377:4 ▶ NF P94-078
- » AASHTO T193
- » EN 13286-47 ▶ UNI 10009
- » ASTM D6927

This program is written to run in MS Windows® for data acquisition and processing of CBR, Marshall, Indirect tensile and generally of load/displacement tests. The software is designed to be used specifically with new Digimax touch 76-P60R02.

MAIN FEATURES

- » Suitable for running CBR, Marshall, Indirect Tensile and universal load/displacement tests
- » Data is presented numerically and graphically in real time
- » Saving and management of tests through single files
- » Single and multiple test result management and printout
- » Data export to MS Excel®
- » Connection to Controls machines with high speed Ethernet connection



82-SW/CMU test data screenshot

Impact soil tester

CLEGG HAMMER
34-T0168/B

Used to obtain an indication of the degree of compaction of soil in road construction. Results can be directly correlated to the CBR test. The unique microprocessor system automatically checks all readings throughout the test and displays the fourth reading as the Impact Value. An essential trench control tool for all cable and pipe laying service contractors.

Specifications

Dimensions: 140 x 140 x 700 mm (approx.)
 Weight: 6.5 kg (approx.)



34-T0168/B

ADVANTAGES

- » Results can be directly correlated to the CBR test
- » An essential trench control tool for all cable and pipe laying service contractors

Strength of stabilized soil

STRENGTH OF STABILIZED SOIL TEST SETS

STANDARD

- ▶ EN 13286-53 ▶ NF P 94-100
- ▶ NF P98-230-2

These tests are performed to determine the unconfined compressive strength of fine and medium grained soils.

Two versions with different sizes are available that conform to:

- EN 13286-53
- NF P 94-100

EN 13286-53 TEST SETS

34-T0123/A

EN stabilized soil set for fine and medium grained soils – specimen size Ø 50 x 50 mm (diameter x height) – EN 13286-53

34-T0123/B

EN stabilized soil set for fine and medium grained soils – specimen size Ø 50 x 100 mm (diameter x height) – EN 13286-53

34-T0124/A

EN stabilized soil set for fine and medium grained soils – specimen size Ø 100 x 100 mm (diameter x height) – EN 13286-53

34-T0124/B

EN stabilized soil set for fine and medium grained soils – specimen size Ø 100 x 200 mm (diameter x height) – EN 13286-53

All above sets include a mould, set of 2 end plugs, set of 2 plug displacing collars with 3 different heights, one demoulding plunger and specimen collector.

All components can be purchased separately.

Approx. weight: 10 kg (34-T0123/A), 12 kg (34-T0123/B), 20 kg

(34-T0124/A) and 53 kg (34-T0124/B)
NF P 94-100 TEST SET

34-T0123/S

NF stabilized soil set for fine and medium grained soils – specimen size Ø 50 x 50 mm (diameter x height) – according to NF P94-100

This set includes a mould, 5 stainless steel casing, 2 compaction plugs, set of plug displacing collars, one demoulding plunger and a specimen collector.

Spares

34-T0123/S1

Set of 5 stainless steel casing for specimen size Ø 50 x 50 mm (diameter x height)



34-T0123/A



34-T0124/B

Field density. Sand replacement method

The verification of the degree of compaction can be determined on site by a simple procedure essentially consists of removing and weighing a part of compacted soil and replacing in the hole with sand by a simple apparatus recording the volume of sand and then calculating the density of the removed soil.

We offer two version according to ASTM/AASHTO/NF and BS

ASTM/AASHTO/NF SAND DENSITY CONE APPARATUS

STANDARD

- ▶ ASTM D1556 ▶ AASHTO T191
- ▶ NF P94-061-3 ▶ UNE 7371, CNR 22

Three versions are available, each suitable for soils of different grain sizes. The sets all include a double cone, a metal base plate and two plastic sand jars, except the 35-T0133 model which is supplied with one acrylic sand container.

The 35-T0129 6.5" (165.1 mm) diameter model can be completed with a calibrating container. See Accessories.

Ordering information

35-T0128
4" dia. (101.6 mm) sand density cone apparatus. Weight approx.. 3 kg

35-T0129
6.5" dia. (165.1 mm) sand density cone apparatus. Weight approx.. 3 kg

35-T0133
12" dia. (304.8 mm) sand density cone apparatus. Weight approx.. 20 kg

Accessories

35-T0130/8
Calibrating container for 35-T0129, 165 mm internal diameter, 187 mm deep.

BS SAND REPLACEMENT APPARATUS

STANDARD

- ▶ BS 1377:9 ▶ BS 1924:2

The operating principle is identical to the ASTM/AASHTO method. Three sizes of apparatus are available, each comprising a pouring cylinder, calibration can and density tray made of plated sheet-steel.

Ordering information

35-T0125
100 mm sand replacement complete set. Weight approx.:7.7 kg

35-T0125/A
150 mm sand replacement complete set. Weight approx.: 13 kg

35-T0126
200 mm sand replacement complete set. Weight approx.:27.5 kg

Accessories

35-T0127
Standard sand 0.2 to 0.6 mm grain size conf. to BS/ASTM/AASHTO. Sack of 50 kg.

Part description*	35-T0128 4" dia.	35-T0129 6.5" dia.
Double cone	35-T0128/1	35-T0129/1
Plastic sand jar (2 pieces)	35-T0130/2	35-T0130/2
Metal base plate	35-T0128/2	35-T0129/2

*All parts can be purchased individually



Sand replacement cones 35-T0128, 35-T0129 and 35-T0133

Part description*	35-T0125 100 mm dia.	35-T0125/A 150 mm dia.	35-T0126 200 mm dia.
Sand pouring cylinder	35-T0125/1	35-T0125/A1	35-T0126/1
Calibration can	35-T0125/2	35-T0125/A2	35-T0126/2
Density tray	35-T0125/3	35-T0125/A3	35-T0126/3



Sand replacement cylinders 35-T0125, 35-T0125/A, 35-T0126

FIELD DENSITY TOOLS

Used to dig, level and remove soil during various field density tests

35-T0140
Metal dibber. Weight 300 g

35-T0141
Scraper. Weight 600 g

35-T0142
Steel pointed rod. Weight 100 g.

35-T0143
Density spoon. Weight 150 g.

35-T0144
Rubber mallet 50 mm dia. Weight 1 kg

35-T0145
Hammer, 300 g.

35-T0145/G
Club hammer, 2 kg.

35-T0146
Density pick. Weight 1 kg.

35-T0147
Chisel 300 mm long. Weight 1 kg.

86-D1348
Lever lid tin, 5 liters cap, Weight 100 g.



Field density

BALLOON METHOD

The principle of operation is similar to the sand replacement method but the hole is filled with a rubber balloon into which water is pumped. The amount of water can be easily determined by reading the graduations marked on the cylinder or piston stress. Two versions are available: the ASTM/AASHTO/CNR model, with 1.6 liter capacity (35-T0131), and the NF version, with 3 or 6 liter capacity (35-T0134 and 35-T0134/A).

35

35-T0131 ASTM/AASHTO BALLOON DENSITY APPARATUS

STANDARD

- ▶ ASTM D2167 ▶ AASHTO T205
- ▶ CNR N° 22

This test set consists of a graduated cylinder with 1596 ml capacity housed inside an aluminum guard, a reversible rubber aspirator pump, a 9" square density plate and 12 rubber balloons.

- Capacity: 1596 ml.
- Weight: 6 kg (approx.)

Accessories and spares

35-T0131/4

Rubber balloons, pack of 12.



35-T0131

NF BALLOON APPARATUS

STANDARD

- ▶ NF P94-061-2

This apparatus is used for determining the in-situ density of well-bonded soil according to NF specifications. A metal cylinder is filled with water which is then pumped into a rubber membrane mounted on the base of the cylinder, which fills a hole previously made in the soil. The water pressure is controlled by a pressure gauge and the volume of the balloon is measured on the graduated piston stem. Two versions are available: 3000 and 6000 ml capacity. The apparatus are supplied complete with base plate, 3 locking clamps and 6 reinforced balloons.

- Weight:
 - 35-T0134, 9.5 kg (approx.)
 - 35-T0134/A, 11.5 kg (approx.)



35-T0134

Ordering information

35-T0134

Balloon density apparatus, 3000 ml capacity.

35-T0134/A

Balloon density apparatus, 6000 ml capacity.

Accessories and spares

35-T0134/2

Spare reinforced 3000 ml membranes for 35-T0134. Pack of 6.

35-T0134/A2

Spare reinforced 6000 ml membranes for 35-T0134/A. Pack of 6.



35-T0134/A

SURFACE SOIL SAMPLERS

In this method a sampling tube is driven into the ground to take a standard core sample, which is then removed, trimmed, and weighed in order to establish the in-situ density of the soil. Two different versions are available, one conforming to ASTM/CNR and one to BS.

ASTM/CNR SURFACE SOIL SAMPLER

STANDARD

▶ ASTM D2937 ▶ CNR N° 22

This apparatus is made from corrosion-resistant steel and consists of a 5 kg sliding-weight drop-hammer which falls freely onto the driving head situated above the sampling tube.

- Weight: 10 kg (approx.).
- Sampling tube: 73 mm internal diameter, 66 mm long.

Ordering information

35-T0135

ASTM/CNR Surface soil sampler.

Accessories and spares

35-T0135/1

Spare thin wall sampling tube, 73 mm internal diameter, 66 mm long.



BS SURFACE SOIL SAMPLERS (CORE CUTTERS)

STANDARD

▶ BS 1377:9

This version of the soil sampler includes a core cutter, driving dolly and driving rammer. Two sizes are available: 100 and 150 mm internal diameter, both made of steel.

Ordering information

35-T0137

100 mm diameter core cutter set.

35-T0138

150 mm diameter core cutter set.



FIELD DENSITY OF UNDISTURBED SOIL

35-T0164

Piston volumeter, 30 cm³ capacity.

This is an easy to use pocket device; very useful for determining the in-situ density of undisturbed soil. A stainless steel tube is driven into the soil and the volume is read off the stem which is marked from 0 to 30 cm³.

- Weight: 0.5 kg (approx.).



Soil samplers parts

Description	35-T0137 100 mm diameter	35-T0138 150 mm diameter
Core cutter (weight)	35-T0137/1 (1 kg)	35-T0138/1 (4.5 kg)
Driving dolly (weight)	35-T0137/2 (1 kg)	35-T0138/2 (4 kg)
Driving rammer (weight)	35-T0137/3 (13.5 kg)	35-T0138/3 (16 kg)
Total weight (approx.)	15.5 kg	24.5 kg

Note: all parts can also be purchased individually

Bearing capacity

STANDARD

- ▶ ASTM D1194 ▶ ASTM D1195
- ▶ ASTM D1196 ▶ BS 1377:9
- ▶ UNE 739 ▶ UNE 7391
- ▶ CNR N° 92 ▶ CNR N° 146

PLATE BEARING TEST APPARATUS 100, 200 AND 500 KN CAPACITY

These test methods are used for estimating the bearing capacity of a soil under field loading conditions for a specific loading plate and depth of embedment. They also cover load tests on soil and flexible pavement components, for use in evaluation and design of airport and highway pavements. The complete kits conforming to BS, ASTM and CNR are identified by a single code (see ordering information).

Alternatively, all components are also proposed individually to design a tailor-made configuration giving the customer maximum flexibility. Plate bearing test apparatus conforming to DIN 18134, Swiss method SNV 70312 and NF P94-117-1 are shown and described on page 138 and 139.

35

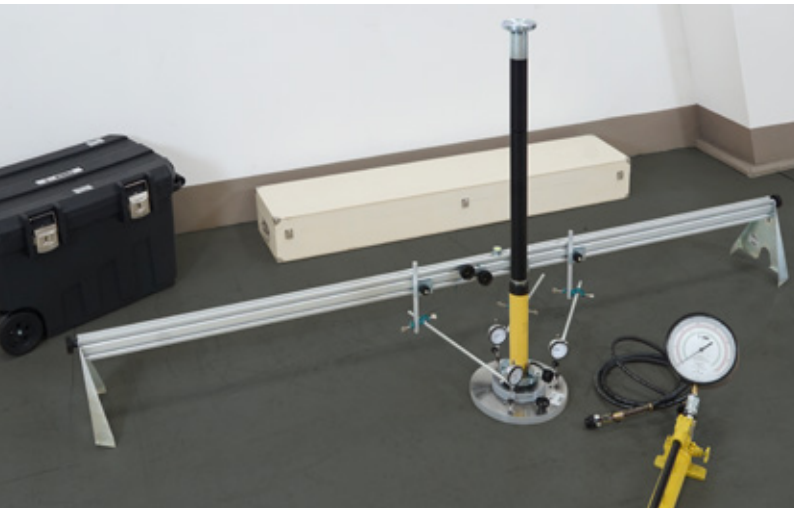

Model 35-T1101, analog version with manometer, 3 dial gauges and carrying cases

MAIN FEATURES

- » 3 capacities: 100, 200 and 500 kN
- » 3 levels of data acquisition matching all technical & budget requirements
- » Analog version with triple scale manometer: force (kN), oil pressure (Bar) and specific load (MN/m²)
- » Digital version with digital read out unit featuring wide graphic display, rechargeable battery and built-in pressure transducer
- » Electronic version with pressure and displacement transducers connected to DATALOG 8 logger, battery operated rugged version ideal for field use
- » Excellent ergonomics: quick assembly/dismount, easy and safe transportation on site with practical carrying cases
- » Heavy duty hydraulic parts and robust loading plates assure total reliability in rough site testing conditions
- » Dual flow manual hand pump with flexible hydraulic hose 3 meters long
- » Loading jack with 2 spherical seats (the upper one is magnetic for simplifying the test execution)
- » Measuring bridge made in aluminum alloy, lightweight, transportable and easy to assembly
- » Complete hydraulic assembly housed in a hard plastic wheeled carrying case
- » Multiple kits to ASTM, BS and CNR
- » Maximum flexibility with infinite tailor-made configurations for non-standard requirements



Plate bearing test apparatus series 35-T1103/xx configurable with 3 different levels of data acquisition system: analog, digital or electronic



Analog version with 30x0.01 mm dial gauges and triple scale manometer



Digital version with 25.4x0.001 mm digital gauges and digital load readout unit (battery operated) with built-in pressure transducer



Electronic version with pressure and displacement transducers 50 mm travel, connected to Datalog 8, battery operated unit with rigid carrying case suitable for use in the field. See page 416.

MAJOR COMPONENTS FOR 100 AND 200 kN CAPACITY

Hydraulic assembly

Composed by: 100 and 200 kN cylinder capacity. Dual flow hand pump with 3 m connecting hose. Two spherical seats: the lower transfer the reaction load to the plate; the upper, mounted at the top end of the loading column, is magnetic to simplify the test execution. Extension rods for closing the gap between upper spherical seat and reaction frame.

Loading plates

The loading plates are made in high strength steel. All plates include practical handles for easy transportation and can be placed in a pyramid arrangement to ensure rigidity. The range includes:

- 160 mm (6") dia. x 25 mm (1")
- 300 mm (12") dia. x 25 mm (1")
- 456 mm (18") dia. x 25 mm (1")
- 608 mm (24") dia. x 25 mm (1")
- 760 mm (30") dia. x 25 mm (1")

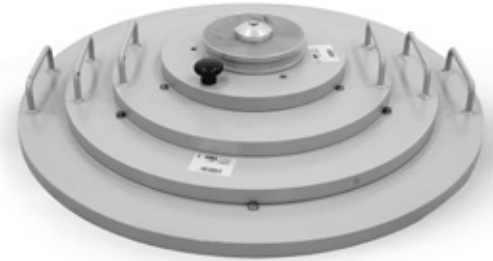

Complete series of loading plate 35-T1100/Px

Load and settlement measurement

Analogic configurations

100 kN capacity precision bourdon gauges 200 mm dia., triple scale:

- force 0-100 kN, div. 0.5 kN
- oil pressure 0-690 Bar, div. 2.5 Bar
- spec. load* 0-1.41 MN/m², div. 0.01 MN/m²

200 kN capacity precision bourdon gauges 200 mm dia., triple scale:

- force 0-200 kN, div. 1 kN
- oil pressure 0-600 Bar, div. 2.5 Bar
- spec. load* 0-2.83 MN/m², div. 0.02 MN/m²

*Note: specific load values refer to a bearing plate with 300 mm dia.

Settlement measurement by 30 x 0.01 mm dial gauges



Triple scale 100 kN manometer

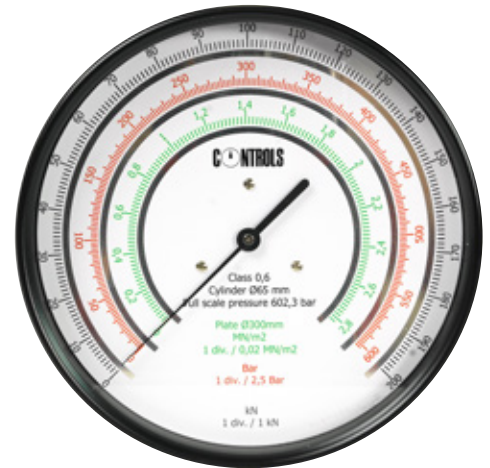

Triple scale 200 kN manometer

Electronic configuration

Comprising pressure and displacement transducers, 50 mm travel, connected to the Datalog 8, battery operated. See page 416

Digital configuration

Digital load readout unit (battery operated) with built-in pressure transducer. Settlement measurement by 25.4 mm x 0.001 mm digital gauges.

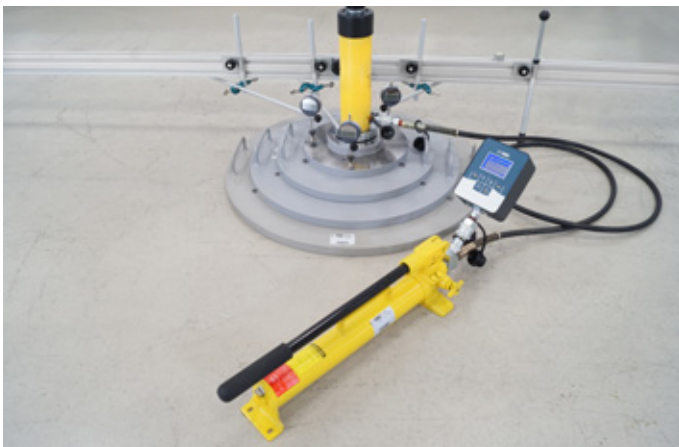

Detail of digital configuration with digital gauges positioned on the bearing plates

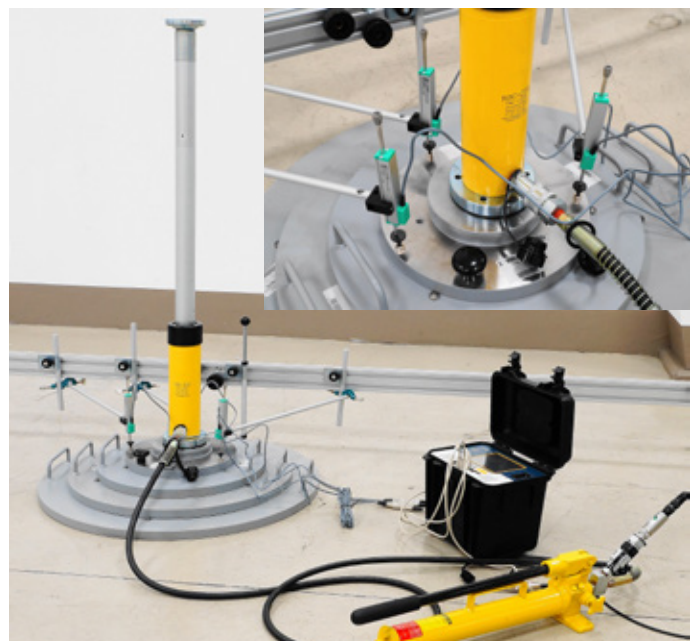

Detail of electronic configuration with displacement transducers positioned on the bearing plates

Bearing capacity

MAJOR COMPONENTS FOR 100 AND 200 KN CAPACITY

Reference bar (measuring bridge)

Made from lightweight aluminum alloy, this reference bar is transportable, quick to assemble on-site, and features two external supports and built-in spirit level. The main measuring bar is 2.5 meter long and can be expanded with extensions up to 5.5 meters total length. Basic or extender measuring bridge and adjustable supports for displacement gauges can be housed in a practical wooden carrying case.

35



Complete measuring bar 5.5 meters long and adjustable supports for displacement devices housed inside the wooden carrying case

Measuring tunnel

It is used for the testing configuration with single displacement device (required by CNR 146 method A). It is compatible with analog, digital dial gauge and electronic displacement transducer.

Only for hydraulic assembly capacity 100 and 200 kN. See 35-T1100/MT

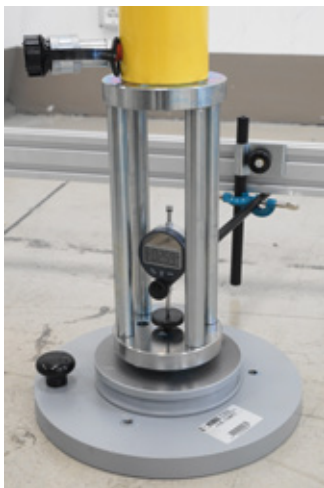

Measuring tunnel 35-T1100/MT suitable for single displacement device configuration

Packing

Complete testing kits 100 and 200 kN capacity include a wheeled plastic carrying case housing the following parts:

- hydraulic assembly (pump, cylinder, extension rods)
- plates diameter 160 mm (6") and 300 mm (12")
- load and displacement devices.

Additional plates diameter 456 mm (18"); 608 mm (24") and 760 mm (30") can be packed in a dedicated wooden box available as accessory. (See next pages, 35-T1100/BOX).

Measuring bridge 2.5 m and extensions may be optionally housed in a wooden carrying case available as accessory. (See 35-T1100/BC).

Complete testing kits housed inside 2 carrying cases for easy transportation on site

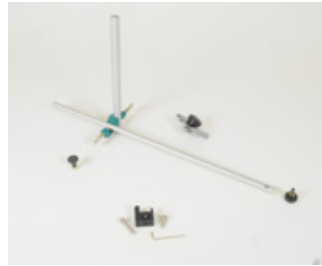
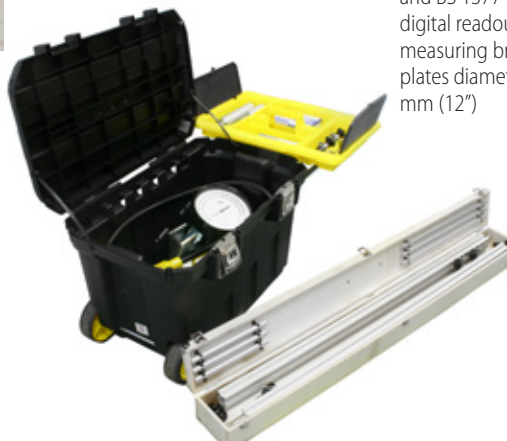

35-T1100/ARM adjustable support for displacement device

Ordering information

All apparatus are supplied complete with trolley type plastic case and cardboard box for the measuring bridge. The set of platens part of the ASTM models 35-T1103/DGT and 35-T1103/EL can be packaged in a wooden box. See accessory 35-T1100/BOX

Analog versions

35-T1100

Plate bearing test apparatus 100 kN cap. to CNR No. 146 method A, analog version with 3 scale manometer, single dial gauge and measuring tunnel, measuring bridge 2.5 m long, loading plates diameter 160 mm (6") and 300 mm (12")

35-T1101

Plate bearing test apparatus 100 kN capacity to CNR No. 146 method B and BS 1377-9, analog version with 3 scale manometer, 3 dial gauges, measuring bridge 2.5 m long, loading plates diameter 160 mm (6") and 300 mm (12").

Digital versions

35-T1100/DGT

Plate bearing test apparatus 100 kN capacity to CNR No. 146 method A, digital version with digital readout unit, single digital gauge and measuring tunnel, measuring bridge 2.5 m long, loading plates diameter 160 mm (6") and 300 mm (12")

35-T1101/DGT

Plate bearing test apparatus 100 kN capacity to CNR No. 146 method B and BS 1377-9, digital version with digital readout unit, 3 digital gauges, measuring bridge 2.5 m long, loading plates diameter 160 mm (6") and 300 mm (12")

35-T1102/DGT

Plate bearing test apparatus 200 kN capacity to CNR No. 146 method B and BS 1377-9, digital version with digital readout unit, 3 digital gauges measuring bridge 2.5 m long, loading plates diameter 160 mm (6") and 300 mm (12")

35-T1103/DGT

Plate bearing test apparatus 200 kN capacity to CNR, BS 1377-9, ASTM D1195, D1196 digital version with digital readout unit, 3 digital gauges, measuring bridge 5.5 m long, loading plates diameter 160 mm (6"), 300 mm (12"), 456 mm (18"), 608 mm (24") and 760 mm (30")

Electronic versions

35-T1100/EL

Plate bearing test apparatus 100 kN capacity to CNR No. 146 method A, electronic version with pressure and single displacement transducers (plus measuring tunnel) connected to DATALOG 8, measuring bridge 2.5 m long, loading plates diameter 160 mm (6") and 300 mm (12")

35-T1101/EL

Plate bearing test apparatus 100 kN capacity to CNR No. 146 method B and BS 1377-9, electronic version with pressure and 3 displacement transducers connected to DATALOG 8, measuring bridge 2.5 m long, loading plates diameter 160 mm (6") and 300 mm (12")

35-T1102/EL

Plate bearing test apparatus 200 kN capacity to CNR No. 146 method B and BS 1377-9, electronic version with pressure and 3 displacement transducers connected to DATALOG 8, measuring bridge 2.5 m long, loading plates diameter 160 mm (6") and 300 mm (12")

35-T1103/EL

Plate bearing test apparatus 200 kN capacity to CNR, BS 1377-9, ASTM D1195, D1196, electronic version with pressure and 3 displacement transducers connected to DATALOG 8, measuring bridge 2.5 m long, loading plates diameter 160mm (6"), 300 mm (12"), 456 mm (18"), 608 mm (24") and 760 mm (30")

MAJOR COMPONENTS FOR 500 KN CAPACITY

Hydraulic assembly

Comprising: 500 kN cylinder capacity; Dual flow hand pump with 3 m connecting hose; Two spherical seats (the lower transfer the reaction load to the plate; the upper, mounted at the top end of the loading column, is magnetic to simplify the test execution); Sturdy extension rods for closing the gap between upper spherical seat and reaction frame.

35-T1100/H5

500 kN capacity loading system conforming to ASTM D1194 and ASTM D1195. It has to be completed with the loading plates and suitable accessories conforming to the selected configuration:

-Analogue

-Digital

-Electronic

Load and settlement measurement

Analog configurations

35-T1100/A5

500 kN capacity precision bourdon gauges 200 mm diameter, triple scale: - force: 0-500 kN, div. 2.5 kN - oil pressure: 0-700 Bar, div. 2.5 Bar - specific load*: 0-7.07 MN/m², div. 0.05 MN/m²,

**Note: specific load values refer to a bearing plate with 300 mm dia.*

35-T1100/ARM**

Adjustable support for displacement device

82-D1257**

Dial gauge 30 mm x 0.01 mm

Digital version

35-T1100/D

Digital load readout unit (battery operated) with built-in pressure transducer

35-T1100/ARM**

Adjustable support for displacement device

82-D1262/B**

Digital gauge 25.4 x 0.001 mm

***Note: quantity in accordance with the numbers of displacement gauges used in the testing configuration, 3 pcs (recommended)*

Electronic version

82-P9008/F

DATALOG 8, 8 channels multipurpose data logger, battery operated and with rigid carrying case ideal for field use.

82-P9008/ELT1**

Single connection cable

35-P0700

Pressure transducer



82-P0349/ELT

Connection cable for pressure transducer

35-T1100/ARM**

Adjustable support for displacement device

35-P0324**

Displacement transducer 50 mm stroke

***Note: quantity in accordance with the numbers of displacement gauges used in the testing configuration, 3 pcs (recommended)*

Loading plates

35-T1100/P6

160 mm diameter (6") x 25 mm (1"). Weight 6 kg

35-T1100/P12

300 mm diameter (12") x 25 mm (1"). Weight 14 kg

35-T1100/P18

456 mm diameter (18") x 25 mm (1"). Weight 28 kg

35-T1100/P24

608 mm diameter (24") x 25 mm (1"). Weight 55 kg

35-T1100/P30

760 mm diameter (30") x 25 mm (1"). Weight 80 kg

Reference bar (measuring bridge)

35-T1100/B25

Datum bar 2.5 m long

35-T1100/BEX

Extension kit to extend the datum bar from 2.5 m to 5.5 m

Note: all above items can be ordered individually providing maximum flexibility with infinite tailor-made configurations for non-standard requirements

Packing

Complete testing kit 500 kN capacity can be housed in practical carrying cases for easy handling of the apparatus on site:

35-T1100/BC

Wooden carrying case for reference bar, 2.5 m and 5.5 m versions

35-T1100/H5C

Wheeled carrying case for 35-T1100/H5, 500 kN hydraulic assembly

35-T1100/BOX

Wooden box for loading plates diameter 456 mm (18") 608 mm (24") and 760 mm (30")



Triple scale 500 kN manometer

Bearing capacity DIN method version

STANDARD

- ▶ DIN 18134 ▶ PN-S-02205
- ▶ BN-64-8931-02 ▶ BS 1377:9

35

DIN PLATE BEARING TEST APPARATUS

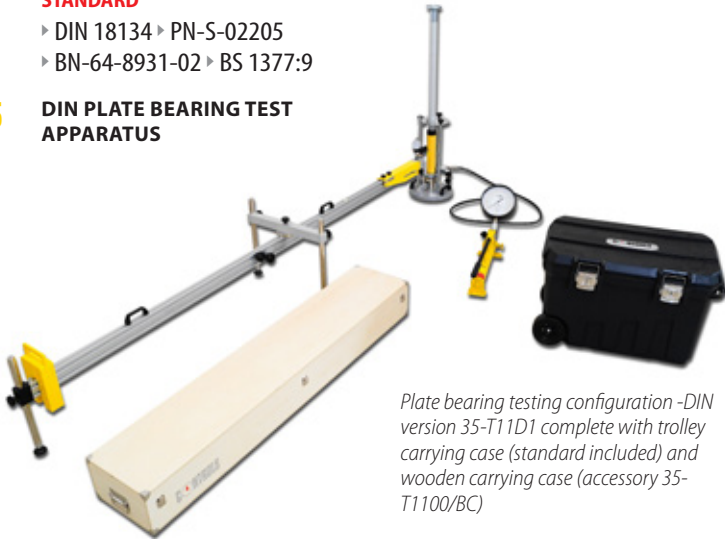

Plate bearing testing configuration -DIN version 35-T11D1 complete with trolley carrying case (standard included) and wooden carrying case (accessory 35-T1100/BC)

The above Standards cover the same determination of the ASTM, BS etc. described on page 134.

The test apparatus comprises by the same components except for the measuring bridge system and tunnel, designed as prescribed by DIN standards.

The test apparatus is available in the Analog or Electronic version, 100 or 200 kN capacity.

Ordering information

Analog configuration

35-T11D1

Plate bearing test apparatus 100 kN capacity conforming to DIN 18134, BS 1377-9. Analog configuration with diameter 200 mm triple scale manometer and dial gauge 30 mm x 0.01 mm

35-T11D2

Plate bearing test apparatus 200 kN capacity. conforming to DIN 18134, BS 1377-9. Analog configuration with diameter 200 mm triple scale manometer and dial gauge 30 mm x 0.01 mm

MAIN FEATURES

- » 4 different configurations with 100 and 200 kN capacity, analog and electronic versions
- » Analog versions fitted with 200 mm diameter triple scale manometer: force (kN), oil pressure (Bar) and specific load (MN/m²)
- » Electronic version fitted with high resolution load cell
- » Dual flow hand pump for quick contact to the reaction frame and for accurate test execution
- » Spherically seated loading jack. The seat surface is magnetic for simplifying the test execution
- » Telescopic measuring bridge made in aluminum alloy, lightweight, transportable and quick to assembly
- » Complete hydraulic assembly housed in a hard plastic wheeled carrying case

Electronic configuration

35-T11D1/EL

Plate bearing test apparatus 100 kN capacity conforming to DIN 18134, BS 1377-9. Electronic configuration with high resolution load cell and displacement transducer 50 mm stroke connected to DATALOG 8 battery operated version with rigid carrying case suitable for field use.

35-T11D2/EL

Plate bearing test apparatus 200 kN capacity conforming to DIN 18134, BS 1377-9. Electronic configuration with high resolution load cell and displacement transducer 50 mm stroke connected to DATALOG 8 battery operated version with rigid carrying case suitable for field use.

Accessories

35-T1100/BC

Wooden carrying case for datum bar

82-D1262/B

High resolution digital indicator 25.4 x 0.001 mm

35-T1100/P600

Loading plate 600 mm dia. x 20 mm reinforced with stiffeners and centering pin suitable for plate bearing test apparatus conforming to DIN Standard, series 35-T11Dx/x

35-T1100/P762

Loading plate 762 mm diameter x 20 mm reinforced with stiffeners and centering pin suitable for plate bearing test apparatus conforming to DIN Standard series 35-T11Dx/x



Detail of the hydraulic assembly of 35-T11D1: load plate diameter 300 mm; hydraulic cylinder with spherical seat and extension rods; telescopic arm; measuring tunnel; anti tilting 3-column jig and dial gauge



Detail of the measuring bridge housed inside the wooden carrying case accessory 35-T1100/BC



Detail of the hydraulic assembly of 35-T11D1: triple scale manometer and digital gauge 82-D1262/B

SWISS method version

STANDARD

► SNV 70312

PLATE BEARING TEST APPARATUS-SWISS METHOD

35-T0121

Used to estimate the bearing capacity of a soil under field loading conditions on flexible pavement components.

The relatively lightweight (68 kg in total) and small dimensions of the apparatus make it very easy to use and to move from one place to another. The measuring bridge made from aluminum alloy, is very light and has telescopic extensions so it can be positioned in a few minutes with minimum effort. The remote load control and

gauge are mounted on the pump and it is not necessary to go near the platen for recording the load.

- The deformations are measured with three dial indicator
- Loading ram cap.: 100 kN
 - Gauge range: 0 to 0.8 MN/m²
 - Dial indicators: No. 3, 30 mm travel 0.01 mm divisions
 - Carrying case dimensions:
 - 1) 1080x360x200 mm
 - 2) 920x360x200 mm
 - Total weight approx.: 68 kg

Ordering information

35-T0121

Platen bearing test apparatus, 100 kN capacity, 300 mm platen diameter



FRENCH method

STANDARD

► NF P94-117-1

ALUMINUM BEARING PLATE 600 MM DIAMETER

This bearing plate is normally used, together with a hydraulic jack, hand pump with manometer and the 80-B0180 Benkelman beam apparatus, for determining the bearing capacity and deflection of road pavements as fully described on page 380.

It can also be conveniently used in plate load testing as an alternative to the standard 300 to 760 mm diameter steel plates. The aluminum bearing plate should be completed with the accessories specified below.

Ordering information

80-B0180/B1

Aluminum bearing plate, 600 mm diameter, with reinforcing ribs. Weight 30 kg(approx.).

Accessories

80-B0180/B2

Hydraulic jack, 200 kN capacity. Weight 10 kg (approx.).

80-B0180/B3

Three interchangeable extensions with spherical seated foot. Weight 12 kg (approx.).

80-B0180/B4

Hand pump with 200 mm diameter high precision manometer. Calibrated in bar (0 to 3.5) and in daN (0 to 10000). Complete with connecting hose. Weight 11 kg (approx.).

80-B0180/B5

Carrying case for the above items except for the 80-B0180/B1. Weight 10 kg.

80-B0180*

Benkelman beam apparatus. Weight 10 kg

80-B0181*

Wooden carrying case for 80-B0180
*For more information see page 380



Dynamic deformation modulus of soil

STANDARD

- ▶ ASTM E2835-11* ▶ TP-BF** -StB part 8.3/2012 ▶ ZTV E-StB 09
- ▶ ZTV T-StB 95 ▶ ZTV A- StB 97 ▶ RVS 8 (Austrian regulations) ▶ RIL 836

*Standard test method for measuring deflections using a portable impulse plate load test device

**German technical test standard for soil and rock in road construction

LIGHTWEIGHT DEFLECTOMETER

35-T0120/A

The dynamic plate load test performed with the lightweight deflectometer is used to determine the soil bearing capacity and compaction quality of soils and non-cohesive subbases, as well as for soil improvement applications. Built-in soil layers can easily be tested without load abutment, facilitating quick assessments of test lots even under limited space conditions. The test method is suited to coarse-grain and mixed grain soils with a maximum grain size of 63mm and can be used to determine the dynamic modulus of deformation of soil in the range $E_{vd} = 15$ to 70 MN/m^2 .



35-T0120/A during operation

Applications

- Road and railway construction, earth moving
- Quality assurance in canal construction
- Compaction monitoring in pipe trenches and cable ducts
- Testing of pavement bedding
- Testing of foundation backfill
- Quality inspection in boreholes
- Testing of modulus of deformation in line with soil exploration

INTRA-COMPANY MONITORING SAVES COSTS!

Being easy to handle and providing immediate measuring results, the lightweight deflectometer is especially suited for monitoring intra-company operations. It facilitates quick decisions for continuing construction at the site. The

documentation can be printed directly at the site via the thermal printer or as a protocol printout after transferring and processing the data on a PC.

ADVANTAGES OF THE DYNAMIC PLATE LOAD TESTING.

- Fast and cost-saving
 - Time-saving (maximum 2 minutes per measuring point)
- No vehicle required
 - Immediate on-site evaluation of test results
- Easy to handle
 - Low tester weight, few components, human-engineered
 - Easy for one person to operate and carry
 - Testing can be achieved in difficult-to-reach locations

- Reliable and precise
 - Calibrated by an approved calibration institute
 - Complies with the latest state of the art technology
 - Field tested and used successfully throughout the world
 - Calibrated according to ASTM E2835-11 by authorization of the Federal Highway Research Institute

Specifications

Loading mechanism

Total weight: 15 kg
 Drop weight: 10 kg
 Maximum impact force: 7.07 kN
 Duration of impact: 17 ms
 Material: zinc coated/hard-chrome plated steel

Load plate

Diameter: 300 x 20 mm
 Total weight: 15 kg
 Material: zinc coated steel

Electronic settlement measuring instrument

Interfaces: USB, Thermal-Printer, GPS
 Power supply: 4 x R6 batteries
 Dimensions: 210 x 100 x 45 mm
 Settlement measuring range: 0.1 to 2.0 mm ± 0.02 mm
 Measuring range: $E_{vd} < 225 \text{ MN/m}^2$
 Temperature range: 0 to 40°C
 Storage capacity of measured data: 500 series

Accessories

35-T0120/A1

Transport cart for easier on-site transport of the lightweight deflectometer between the measuring points.

35-T0120/A2

Magnetic base plate for proper positioning of loading unit.

35-T0120/A5

Transport box for secure transport of the lightweight deflectometer to the site and between measuring points.

Note: thermal printer and PC software for data processing and storage are included with the apparatus.



35-T0120/A2



35-T0120/A5



35-T0120/A



35-T0120/A1

Soil permeability: constant and falling head apparatus

STANDARD

- ▶ ASTM D2434-06 ▶ BS 1377:5
- ▶ BS EN ISO 17892-11
- ▶ AASHTO T215

CONSTANT HEAD APPARATUS

This method describes a procedure for the determination of the permeability of water through granular (cohesionless) soils in a steady-state condition. The procedure is to establish representative values of the coefficient of permeability, *k*, of granular soils that may occur in natural depos-

its as placed in embankments, or when used as base courses under pavements. The determination of *k* was developed under the assumptions of the validity of Darcy's Law, which states that the coefficient of permeability is the ratio of the flow rate to the hydraulic gradient. In order to limit consolidation influences during testing, this procedure is limited to disturbed granular soils with permeability in range of 1 to 1x10⁻⁵. For a complete list of test accessories see table.

STANDARD

- ▶ BS EN ISO 17892-11
- ▶ ASTM D5856

FALLING HEAD APPARATUS

The falling head permeability test is used to determine the permeability of fine grained soils with intermediate and low permeability such as silts and clays with permeability in range of 1x10⁻⁵ to 1x10⁻⁹. This testing method can be applied to an undisturbed sample. The falling head principle can be applied to an undisturbed

sample in a sampling tube and to a sample in an oedometer consolidation cell.

This test method covers laboratory measurement of the hydraulic conductivity of laboratory-compacted materials with a rigid-wall, compaction-mould permeameter and may be used with compacted specimens that have a hydraulic conductivity less than or equal to 1 × 10⁻⁵ m/s.

For a complete list of test accessories see table.

38

Ordering information (Including all test accessories)

	Constant Head		Falling Head	
Permeability Cell	38-T0184/C1*	Constant Head permeability cell, 75 mm internal dia., 3 take-off points.	38-T0185/C1*	Falling head permeability cell, 100 mm internal dia. Complete with 75 micron gauze and 2 m of tubing conforming to BS EN ISO 17892-11
	38-T0184/C2	Constant Head permeability cell, 114 mm internal dia., 6+6 (blanked) take-off points.	38-T0185/C2**	Compaction mould permeameter, 4" (101,6 mm) dia. conforming to ASTM D5856
38-T0185/C3			Compaction mould permeameter, 6" (152,4 mm) dia. conforming to ASTM D5856	
Tank	38-T0184/T*	Constant level tank. Complete with inlet, outlet, overflow, connecting tubing for the cell.	38-T0185/T*	Soaking reservoir, complete with overflow tube
Manometer Stand	38-T0183/MS*	Manometer stand with 4 tubes positioning. Tubes, ruler and anchoring system has to be ordered separately. Dimensions: 1152 x 250 x 34 mm	38-T0183/MS**	Manometer stand with 4 tubes positioning. Tubes, ruler and anchoring system has to be ordered separately. Dimensions: 1152 x 250 x 34 mm
Ruler	38-T0183/R*	Ruler for T0183/MS	38-T0183/R	Ruler for T0183/MS
Manometer Tubes	38-T0183/6*	Manometer tube 6 mm dia. Connecting valve has to be ordered separately (T0183/6C)	38-T0183/6**	Manometer tube 6 mm dia. Connecting valve has to be ordered separately (T0183/6C)
	38-T0183/8	Manometer tube 8 mm dia. Connecting valve has to be ordered separately (T0183/8C)	38-T0183/8**	Manometer tube 8 mm dia. Connecting valve has to be ordered separately (T0183/8C)
	38-T0183/14	Manometer tube 14 mm dia. Connecting valve has to be ordered separately (T0183/14C)	38-T0183/14**	Manometer tube 14 mm dia. Connecting valve has to be ordered separately (T0183/14C)
	38-T0183/22	Manometer tube 22 mm dia. Connecting valve has to be ordered separately (T0183/22C)	38-T0183/22	Manometer tube 22 mm dia. Connecting valve has to be ordered separately (T0183/22C)
Anchoring System	38-T0183/A	Anchoring system to fix manometer tubes with connecting valves on T0183/MS	38-T0183/A**	Anchoring system to fix manometer tubes with connecting valves on T0183/MS
Control Panel	38-T0183/P	Control Panel used for saturating sample	38-T0183/P	Control Panel used for saturating sample

Note-1: * Standard configuration for Constant Head apparatus a in 38-T0184/KIT

Note-2: * Standard configuration for Falling Head apparatus included in 38-T0185/KIT 1.

** Standard configuration for Falling Head apparatus for compacted soil included in 38-T0185/KIT 2

Ordering information

38-T0184/KIT

Constant Head apparatus complete with T0184/C1, T0184/T, T0183/MS, T0183/R and T0183/6 x3

Ordering information

38-T0185/KIT1

Falling Head apparatus complete with T0185/C1, T0185/T, T0183/MS, T0183/A, T0183/6, T0183/8 and T0183/14

38-T0185/KIT2

Falling Head apparatus for compacted soil complete with T0185/C2, T0185/T, T0183/MS, T0183/A, T0183/6, T0183/8 and T0183/14

Soil permeability: constant and falling head apparatus

Permeability and Drainage Characteristics of Main Soil Type

38

k = m/s	k = 1	10 ⁻¹	10 ⁻²	10 ⁻³	10 ⁻⁴	10 ⁻⁵	10 ⁻⁶	10 ⁻⁷	10 ⁻⁸	10 ⁻⁹	10 ⁻¹⁰	10 ⁻¹¹	10 ⁻¹²
Drainage Characteristics	Good			Poor			Practically Impervious						
Permeability Classification	High		Medium		Low		Very Low		Practically Impermeable				
General Soil Type	Gravels	Clean Sands		Fissured and Weathered Very Fine or Silty Sands				Intact Clays					
Test Method	CH Cell 114 mm dia.		CH Cell 75 mm dia.		FH Cell				FH in Oedometer				
Standards	ASTM D2434-06 / BS 1377:5 BS EN ISO 17892-11 / AASHTO T215.				BS EN ISO 17892-11 ASTM D5856				BS EN ISO 17892-11				



T0184/KIT with T0183/P

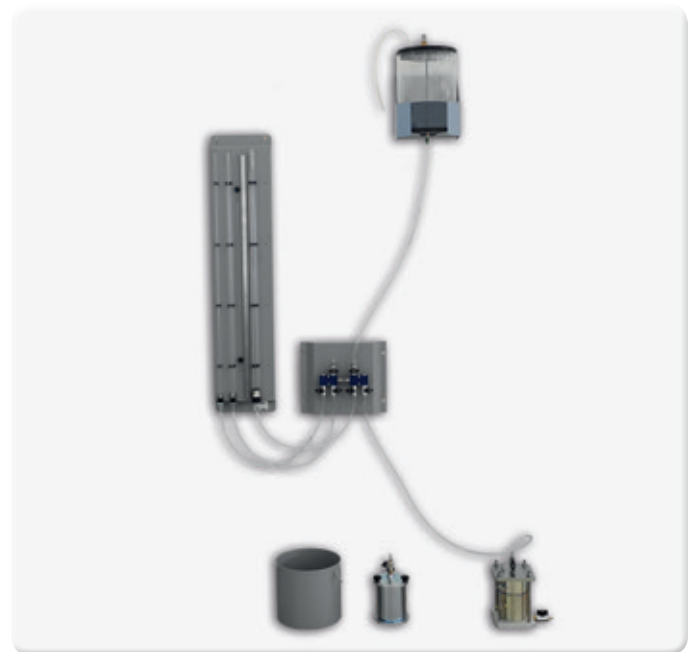

T0183/KIT2 with T0183/P, T0185/C1 and de-airing tank T0185/T



T0185/C1



38-T0185/C2



38-T0184/C1

DE-AIRING AND VACUUM SYSTEM

De-airing tanks

Used in conjunction with a vacuum source and related accessories, this item provides a very efficient and therefore quick means of removing the air from water. For detailed information please see page 82

Two models are available:

28-WF4220/A

7 liter capacity de-airing tank.
Overall dimensions: 579 x 200 x 209 mm.
Weight: 6.4 kg (approx.).

28-WF4221/A

23 liter capacity de-airing tank.
Overall dimensions: 619 x 320 x 311 mm.
Weight: 12 kg (approx.).



28-WF4221/A

VACUUM PUMP

86-D2001

Portable vacuum pump.
Free air displacement: 75 l/min.
Ultimate vacuum: 0.1 mbar.
230 V, 50-60 Hz, 1 ph.

86-D2001/Z

As above but 110 V, 60 Hz, 1 ph.

86-D0819

Silica gel desiccant with indicator, 1000 g bottle.

86-D2064

Rubber tube for vacuum pump.
ID 6.5 mm, OD 16.5 mm.

tank to prevent / limit water vapour mixing with the oil of the vacuum pump, which, in significant quantities, may cause serious damage to the pump. 86-D0819, 86-D2005 It has to be filled with a suitable desiccant (e.g. Silica gel desiccant 86-D0819). For more details about complete de-airing systems. See page 82

86-D2004/3

Vacuum gauge, range 0-760 mm/hg (0-1 bar), with base, complete with pin regulating valve.
Resolution, 10mm/hg (0,02 bar)
Weight 0.5 kg

AIR DRYING UNIT

86-D2005

Air drying unit
This item is installed between the vacuum pump and the deairing



86-D0819, 86-D2005

STANDARD

▶ ASTM D2434

38-T0186

COMBINED CONSTANT OR FALLING HEAD APPARATUS

This apparatus can be used for either the constant or falling head method, to determine the soil permeability. It consists of a two-section plastic chamber, a plated steel top with gaskets, a plastic funnel reservoir (with a maximum head of 550 mm with the reservoir upright) and a 100 cc pipette. Also included are two porous stones, 63.5 mm diameter by 12.7 mm thick, with an average pore size of 300 microns.
weight: 4.5 kg (approx.)

Spare parts

38-T0186/1

Spare porous stone 63.5 mm diameter x 12.7 mm thick. Pack of 5.



STANDARD

▶ ASTM D4647 ▶ BS 1377:5

38-T0189/A

PINHOLE TEST APPARATUS

Certain fine-grained soils with a high sodium content are highly susceptible to erosion by the water flowing through them. During the dispersibility test the flow of water through a cavity in the soil under a high hydraulic gradient is reproduced.

The test apparatus consists of a cylindrical metal container fitted with a water inlet at one end and an outlet connection at the other, a standpipe tube with scale, and a stand to support the pinhole apparatus.

Weight: 3.5 kg (approx.).

Accessories

38-T0184/T

Constant level tank. Complete with inlet, outlet, overflow.

