



# CONCRETE

Air Indicators . . . . .	161, 164	Flexural Beam Testing, Portable . . . . .	200
Air Meters . . . . .	160-163	Freeze-Thaw . . . . .	223-224
Bond Test, Pull-Off . . . . .	220-222	Ground Penetrating Radar . . . . .	208-209
Compaction . . . . .	172	Initial Set . . . . .	165
Compression Machines . . . . .	187-198	Linear Traverse . . . . .	226
Compression Machines Controllers . . . . .	189	Molds . . . . .	172-184
Compression Testing . . . . .	199	Beam and Cube . . . . .	172
Compressive Strength . . . . .	207	Cylinders . . . . .	173-174
Consistency . . . . .	169	Mold Strippers . . . . .	173
Corrosion . . . . .	212-213	Masonry Saws . . . . .	183
Crack Monitors . . . . .	227-228	Maturity . . . . .	170
Curing Room Humidity System . . . . .	178-180	Mixers . . . . .	171
Cylinder Capping . . . . .	185-186	Moisture in Slabs . . . . .	229-230
Cylinder Prep . . . . .	184	Rebar Location . . . . .	210-211
Cylinder Grinder . . . . .	181-182	Rebound Test Hammers . . . . .	205-206
Cylinder Transport & Storage . . . . .	175-177	Relative Humidity . . . . .	181
Echo, Pulse & Sonic . . . . .	217	Resistivity . . . . .	218-219
Flexural Beam Testing . . . . .	201-204	Self-Consolidating Concrete . . . . .	168
		Super Air Meter . . . . .	225
		Slump Testing . . . . .	166-167
		Strain . . . . .	226
		Ultrasonic . . . . .	213-217
		Unit Weight . . . . .	164
		Water Impermeability . . . . .	225







H-2783A



H-2786C



H-2786

**Humboldt Concrete Air Meter**

ASTM C231, AASHTO T152

The H-2783A air meter, which exceeds ASTM requirements, features the Humboldt, all-brass super pump, the most reliable and highest quality pump available. The meter's easy-to-use, and extra durable stainless steel clamping system employs four, one-piece, self-locking clamps that quickly seal the lid to the base with proper tension aided by an o-ring to assure a watertight seal. The large, easy-to-read, 4-inch diameter, heavy-duty, direct percentage gauge with calibration adjustments is accurate to the nearest 0.1%. The bucket, or pressure chamber, features EZ-grip, cast handles, which improve usability. This is especially true when the bucket is also used as a 0.25 cu. ft. unit weight measure. The lid of the pressure meter features a smooth sloped top so water and concrete wipe right off. By eliminating the cavities in the lid that trap and hold concrete, maintenance and repair problems are greatly reduced. The meter also features a machined base, which ensures the meter sets level when conducting tests. The kit includes a durable plastic carrying case; a tamping rod; strike-off bar; rubber bulb syringe; plastic calibration vessel; inside calibration tube, outside calibration tube and operating instructions.

**Features Include:**

- Humboldt all-brass Super Pump
- Large, heavy-duty, easy-to-read gauge
- Cast handles for secure grip
- Bucket can be used as a 0.25 cu. ft. unit weight measure
- Complete with all needed accessories and case

**Humboldt Concrete Air Meter H-2783A**



Ship wt. 36lbs. (16.3kg)

**Concrete Air Meter**

ASTM C231, C192, AASHTO T152

The H-2786C air meter features a simplified, low-maintenance design, which uses no moving parts inside the chamber. Pressure is released into the base by an external, brass, quick-release T-valve. The meter uses brass cover clamps, which can be adjusted for clamping pressure. A large, easy-to-read, 4" diameter, direct percentage gauge with calibration adjustments is accurate to the nearest 0.1%. The base is machined inside and out for easy cleaning and the chamber and cover are one solid component, eliminating bottom gasket leaks. The H-2786C air meter also features the Humboldt, all-brass super pump, the most reliable and highest quality pump available. The meter's base/bucket can be used as a 0.25 cu. ft. unit weight measure. The kit includes a durable plastic carrying case; tamping rod; strike-off bar; wash bottle; plastic calibration vessel; inside calibration tube, outside calibration tube and operating instructions.

**Concrete Air Meter**

**H-2786C**



Ship wt. 34.9lbs. (15.9kg)

**Press-Ur-Meter Concrete Air Meter, Wood Case**

ASTM C231, C192, AASHTO T152

This is the original Press-Ur-Meter for field and laboratory tests. This air meter is designed to provide air content and the determination of specific gravity and free moisture of aggregate. Designed to save time, reduce water use, ensure accuracy and maintain sample integrity (sample may also be used for slump and compression tests). The meter uses brass cover clamps, which can be adjusted for clamping pressure. A large, easy-to-read, 4" diameter, direct percentage gauge with calibration adjustments is accurate to nearest 0.1%. The H-2786 meter also features the Humboldt, all-brass super pump, the most reliable and highest quality pump available. The meter's base/bucket can be used as a 0.25 cu. ft. unit weight measure. This kit includes a wood carrying case; tamping rod; strike-off bar; rubber bulb syringe; aluminum calibration vessel; inside calibration tube, outside calibration tube and operating instructions.

**Press-Ur-Meter with Vertical Wood Case H-2786**



Ship wt. 30lbs. (13.6kg)



Looking for the Humboldt Super Air Meter?

See page 225

H-2784





H-2786P



H-2787



H-2782

H-2781

**Press-Ur-Meter Concrete Air Meter, Plastic Case**  
ASTM C231, C192, AASHTO T152

This is the original Press-Ur-Meter for field and laboratory tests. This air meter is designed to provide air content and the determination of specific gravity and free moisture of aggregate. Designed to save time, reduce water use, ensure accuracy and maintain sample integrity (sample may also be used for slump and compression tests). The meter uses brass cover clamps, which can be adjusted for clamping pressure. A large, easy-to-read, 4" diameter, direct percentage gauge with calibration adjustments accurate to the nearest 0.1%. The H-2786 meter also features the Humboldt, all-brass super pump, the most reliable and highest quality pump available. The meter's base/bucket can be used as a 0.25 cu. ft. unit weight measure. This kit includes a molded-plastic carrying case; tamping rod; strike-off bar; rubber bulb syringe; aluminum calibration vessel; inside calibration tube, outside calibration tube and operating instructions.

**Press-Ur-Meter with Horizontal Plastic Case H-2786P**



Ship wt. 30lbs. (13.6kg)

**Concrete Air Meter**

ASTM C231, C192, AASHTO T152

The H-2787 air meter is one of the most precise air content measuring devices available. With heat-treated, cast aluminum construction and cast-in handles on the base, the H-2787 is heavy duty, yet lightweight, and easy to handle. This air meter utilizes the best clamping system available, with large stainless steel clamp levers and a holding capacity of 2500 lbs. each. This clamping system provides an easy, dependable operation. Employing the use of a superior, high-volume Pump, this system makes operation efficient yet rapid. The meter includes a large, accurate pressure gauge with safety glass and bold color dial face. Color coded for entrapped and entrained air readings. The kit includes a durable plastic carrying case; tamping rod; strike-off bar; wash bottle; plastic calibration vessel; inside calibration tube, outside calibration tube and operating instructions.

**Concrete Air Meter**

**H-2787**



Ship wt. 38lbs. (17.2kg)

**Air Entrainment Meter, 5 Liter**

ASTM C231, EN 12350-7, BS 1881, GOST 10181

The H-2781 5 Liter air meter features push-buttons for simple test performance. The meter's easy-to-use, and extra durable stainless steel clamping system employs four, one-piece, self-locking clamps that quickly seal the lid to the base with proper tension aided by an o-ring to assure a watertight seal. It also features durable, stainless steel handles. The large, easy-to-read, 4-inch (100mm) dia., heavy-duty, direct percentage gauge with calibration adjustments is accurate to the nearest 0.1%. This gauge is built into the meter's cover for excellent protection from damage. The meter also features a machined base, which ensures the meter sets level when conducting tests. The air meter includes a calibration kit and operating instructions. A case can be ordered below.

**Air Entrainment Meter, 5L**

**H-2781**

**Air Entrainment Meter, 8L**

**H-2782**



Ship wt. 19.8lbs. (9.0kg)



H-2756

**Chace Concrete Air Indicator Kit**  
AASHTO T199

(Isopropyl-Alcohol Method) Complete kit for measuring air content of fresh concrete includes H-2755 Chace air indicator, instructions, cleaning brush and plastic squeeze-type bottle for alcohol in plastic storage box. Glass tube provides marked lines on stem for estimating total air content. Kit does not replace conventional air meters.

**Chace Concrete Air Indicator Kit H-2756**



Ship wt. 1.4lbs. (1.8kg)



H-2755

**Chace Concrete Air Indicator**  
AASHTO T199

For quick field checks for air content of fresh concrete in about three minutes, pocket-sized unit air meter is furnished with instructions and correlation chart. Glass tube provides marked lines on stem for estimating total air content. Air Indicator includes brass cup and stopper. Unit does not replace conventional air meters. Overall Dimensions: 6.25 x 1.125" dia. (159 x 29mm).

**Chace Concrete Air Indicator**

**H-2755**



Ship wt. 0.25lbs. (.45kg)

**Air Entrainment Meter Accessories**

Item	Part No.
Transport Case, Aluminum	H-2782.1

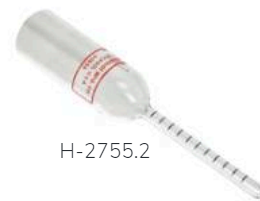

H-2755.2

**Chace Air Indicator Glass Filter Tube Only**  
AASHTO T199

Glass tube provides marked lines on stem for estimating total air content. Does NOT include brass cup and stopper.

**Chace Glass Filter Tube only**

**H-2755.2**



Ship wt. 0.2lbs. (.45kg)





H-2789



H-2793



H-2788



H-2783.30



H-2785.34



H-2783.31

**Air Meter Calibrators (5%)**

Calibrators check the accuracy of any pressure-type concrete air meter. Set the specially-designed canister upright at the bottom of the water-filled base, and the meter should read 5% air by volume. Two calibrators are used for a 10% air reading.

**Air Meter Calibrator, Brass** H-2789

**Air Meter Calibrator, Aluminum** H-2793

**Air Meter Calibrator, Plastic** H-2788

Ship wt. 3lbs. (1.3kg)



H-2785.31



H-3399



H-2785.36



H-2785.32



H-2785.33



H-2786C.32

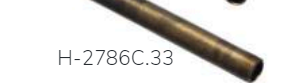

H-2786C.33



H-2783.26

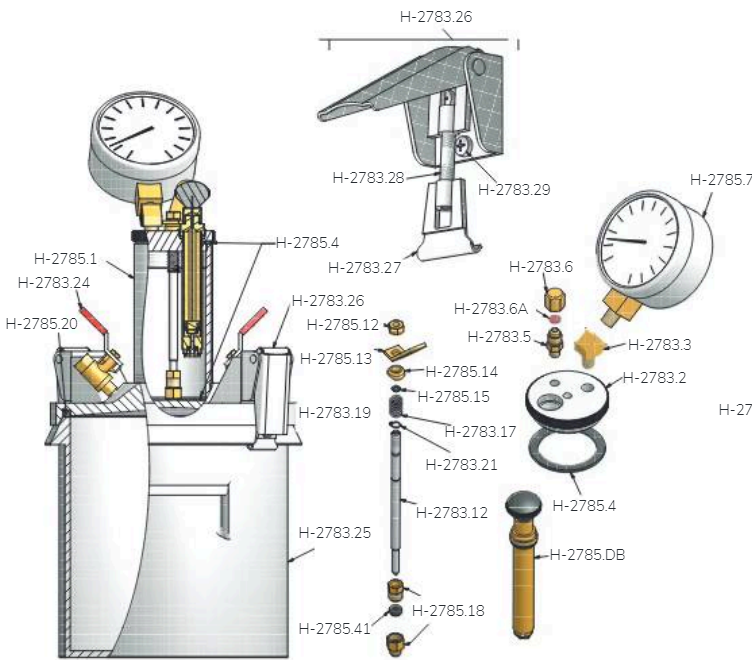

**H-2783 Air Meter Replacement Items**

Description	Part No.	Description	Part No.
Pressure chamber	H-2785.1	Needle valve seat assembly	H-2785.18
Pressure chamber cap	H-2783.2	Cover	H-2783.19
Pressure chamber elbow	H-2783.3	Cover o-ring	H-2785.20
Pressure chamber gasket	H-2785.4	Needle valve spring retainer	H-2783.21
Air-release stem	H-2783.5	Cover petcock	H-2783.25
Air-release cap	H-2783.6	Base	H-2783.25
Release cap gasket	H-2783.6A	Needle valve seat gasket	H-2785.41
Air meter gauge	H-2785.7	Latch assembly	H-2783.26
Needle valve stem	H-2783.12	Latch	H-2783.27
Needle valve nut	H-2785.12	Adjusting rod	H-2783.28
Needle valve lever	H-2785.13	Latch assembly screw	H-2783.29
Needle valve spacer	H-2785.14	Super Pump assembly	H-2785.DB
Needle valve o-ring	H-2785.15	Gasket replacement kit	H-2783.39
Needle valve spring	H-2783.17	Case	H-2783.70

**H-2786C Air Meter Replacement Items**

Description	Part No.	Description	Part No.
Gauge, complete	H-2785.7	Clamp toggle lock nut	H-2785.27
Pressure chamber elbow	H-2785.3	Spring	H-2785.25
Gasket, pressure chamber	H-2786C.3	Toggle	H-2786C.26
Pressure chamber cap	H-2786C.2	Clamp	H-2786C.22
Air-release stem	H-2786C.5	Super Pump adapter	H-2786C.10
Pot (base only)	H-2786C.29	O-ring, lower for adapter	H-2786C.9A
Release cap and gasket	H-2786C.6	O-ring for tube	H-2785.53
Release cap gasket only	H-2786C.6A	Pot, base only	H-2786C.29
Valve assembly, complete	H-2786C.11SA	Lid only	H-2786CL
Cover o-ring	H-2785.20	Super Pump	H-2785.DB
Clamp trunnion	H-2785.24	Gasket replacement kit	H-2786C.55
Nut, clamp	H-2785.23	Latch assembly complete	H-2786C.40









H-2796A



ASTM Unit Weight Measures



Non-ASTM Unit Weight Measures



H-2795P

**Roll-A-Meter Air Indicator**

ASTM C173, AASHTO T196

This lightweight aluminum Roll-A-Meter is used to determine the air content of concrete mixes, and is recommended for concrete containing lightweight aggregate, air-cooled slag or highly porous aggregate. The meter's fast acting one-piece, self-locking stainless steel clamps assure a watertight seal between the top section and bowl. A see-through window in the neck has easy to read engraved scale graduated from 0 to 9% with .25% sub-graduations. A durable plastic carrying case with a tough die cut closed cell hard foam insert protects the meter and its accessories. Kit includes: Meter, carrying case, tamping rod, baffle funnel, strike-off bar, calibration measuring vessel, syringe, 16 oz. measuring cup, spanner wrench and manual.

**Roll-A-Meter Air Indicator**

**H-2796A**

Ship wt. 29.8lbs. (11.4kg)

**Volumetair Air Meter**

ASTM C173, AASHTO T196

The volumetair is used for the rolling method of measuring entrained air in any concrete. This ultra lightweight and easy-to-use instrument is supplied complete with the meter, funnel, syringe, tamper, calibration cup, mallet, strike-off bar and plastic carrying case. The plastic materials used in the construction of this unit not only make it lightweight; but also allow the user to use water for clean-up and small amounts of muriatic acid for periodic cleaning. The sight tube has a range of 0 to 9% and the base volume is 134 cu. in. (2200ml).

**Volumetair Air Meter**

**H-2795P**

Ship wt. 19lbs. (6.8kg)

**ASTM Unit Weight Measures**

ASTM C29, C138, C192, AASHTO T19, T121, T158

Machined aluminum, cylindrical unit weight measures with handles for determining unit weight of fine, coarse or mixed aggregates. Water-tight with true and even top and bottom. Measures retain form after repeated use.

**ASTM Measures**

see chart

Ship wt. see chart

**Non-ASTM Unit Weight Measures**

Heavy-gauge, seam-welded, water-tight, steel unit weight measures with bail handles. Can be used for concrete or aggregate. Do not meet ASTM specifications.

**Non-ASTM Measures**

see chart

Ship wt. see chart

**Strike-Off Plates**

ASTM C29, C138, C192, AASHTO T19, T121, T158

Clear .625" (15.8mm) thick, acrylic plates used to strike off surface of unit weight measure samples. Use a plate that is 2" (50.8mm) larger than the diameter of the unit weight measure.

Size sq. in. (mm sq.)	Ship Wt. lbs. (kg)	Model
8 (203)	2.3 (0.9)	H-3669.1P
10 (254)	4 (1.0)	H-3669.4P
12 (305)	5.1 (2.3)	H-3669.2P
16 (406)	8 (3.6)	H-3669.3P

**Strike-Off Plates**

see chart above

**ASTM Unit Weight Measures**

Capacity cu. ft. (liter)	Inside Dia. in. (mm)	Inside Ht. in. (mm)	Ship Wt. lbs. (kg)	Model
1/10 (2.8)	6 (152)	6.1 (155)	6.5 (2.7)	H-3660.1
1/4 (7.1)	8 (203)	8.8 (224)	9.4 (4.9)	H-3664.1
1/3 (9.3)	8 (203)	11.5 (292)	17 (7.7)	H-3663.1
1/2 (14.1)	10 (254)	11 (279)	20 (7.2)	H-3661.1
1 (28.3)	14 (356)	11.2 (155)	22 (13.6)	H-3662.1

**Non-ASTM Unit Weight Measures**

Capacity cu. ft. (liter)	Inside Dia. in. (mm)	Inside Ht. in. (mm)	Ship Wt. lbs. (kg)	Model
1/10 (2.8)	6 (152)	6.1 (155)	6.5 (3.2)	H-3660
1/4 (7.1)	8 (203)	8.8 (224)	15 (6.8)	H-3664
1/3 (9.3)	8 (203)	11.5 (292)	15.8 (8.7)	H-3663
1/2 (14.1)	10 (254)	11 (279)	20 (10)	H-3661
1 (28.3)	14 (356)	11.2 (155)	33 (15)	H-3662

**Tamping (Puddling) Rod**

Round, straight steel rod for use with concrete cylinder molds, slump cones and unit weight measures. Rod measures .625" (16mm) dia. x 24" (610mm) long. Both ends are rounded to hemispherical tip. Plated for rust resistance.

**Tamping (Puddling) Rod**

**H-3650**

Ship wt. 3lbs. (0.9kg)



H-3669.4P



H-3650

**ACCESSORIES**  
 Portable Scales for use with Unit Weight measurements,  
 Go to Pages 359-360.





**Acme Penetrometer**

ASTM C403, AASHTO T197

Hydraulic reaction-type apparatus for determining the setting time of concrete with slump greater than zero by testing mortar sieved from the concrete mixture. It also determines the effects of variables, such as temperature, cement mixture proportions, additions and admixtures upon the time of setting and hardening of concrete. The penetrometer's design makes it easy to operate, being more efficient, with a longer gear rack. All needles are one length so settings may remain the same. Loads are applied hydraulically with pressures read on a 200 lbf (890N) capacity gauge graduated in 2 lbf divisions. Set of six needles allows multiplication to a maximum reading of 8000 lbf. The acme penetrometer features cast aluminum base and set of stainless steel penetration needles in a wooden block (bearing area: 1, 1/2, 1/4, 1/10, 1/20 and 1/40 sq. in., (645, 323, 161, 65, 32 and 16mm<sup>2</sup>). Includes 100 laboratory test data reporting forms.

**Acme Penetrometer**

**H-4133**



Ship wt. 40lbs. (18kg)

**Data Sheets, Time of Set**

ASTM C403, AASHTO T197

Time of setting data sheets for use with the H-4133 and H-4137. Package of 100 sheets.

**Data Sheets, Time of Set**

**H-4133F**



Ship wt. 3.3lbs. (1.45kg)

**Resistance Needle Set**

ASTM C403, AASHTO T197

Set of six, stainless steel needles and holding block for use with the H-4133 acme penetrometer mortar penetration resistance apparatus. Set includes all needles in chart below. Needles are also available individually. See table below.

Description	Part No.
1 sq. in. (645mm <sup>2</sup> )	H-4133.15
1/2 sq. in. (323mm <sup>2</sup> )	H-4133.16
1/4 sq. in. (161mm <sup>2</sup> )	H-4133.17
1/10 sq. in. (65mm <sup>2</sup> )	H-4133.18
1/20 sq. in. (32mm <sup>2</sup> )	H-4133.19
1/40 sq. in. (16mm <sup>2</sup> )	H-4133.20

**Resistance Needle Set**

**H-4133N**



Ship wt. 1.2lbs. (0.5kg)

**Concrete Pocket Penetrometer**

ASTM C403, C780

Lightweight, spring-reaction type concrete penetrometer for field and lab evaluation of the initial set of concrete mortar, based on ASTM C403. Penetration plunger has a 1/20 sq. in. tip area. Plunger is steadily pushed into the mortar to a 1 in. depth, as indicated on the shaft, at periodic time intervals. The penetrometer's calibrated range is 0-700 psi. Resistance in psi is indicated on the scale. The term "initial set" is the semi-hardened, partially hydrated condition of the concrete beyond which it can no longer be worked. The point of initial set is reached when the penetration value is 500psi.

**Concrete Pocket Penetrometer**

**H-4134**



Ship wt. 0.9lbs. (.45kg)

**Concrete Pocket Penetrometer, w/Dial**

ASTM C403, C780

Lightweight, spring-reaction type concrete penetrometer for field and lab evaluation of the initial set of concrete mortar, based on ASTM C403. Penetration plunger has a 1/20 sq. in. tip area. Plunger is steadily pushed into the mortar to a 1" depth, as indicated on the shaft, at periodic time intervals. Penetrometer's calibrated range is 0-700 psi. Resistance in psi is indicated on the scale. The term "initial set" is the semi-hardened, partially-hydrated condition of the concrete beyond which it can no longer be worked. The point of initial set is reached when the penetration value is 500 psi.

**Concrete Pocket Penetrometer w/Dial H-4132**



Ship wt. 0.9lbs. (.45kg)

**Penetrometer Foot**

ASTM C403, C780

For use with masonry mortars to determine board life and initial consistency. Method can be used as a basis for acceptance of mortars. Stainless steel disk, 2.70" (68.58mm) dia. Can be used with H-4134 or H-4132 Penetrometers.

**Penetrometer Foot**

**H-4134F**



Ship wt. 2.2lbs. (.99kg)





H-3637 and H-3635 Slump Cone Sets feature Easy-Carry Configuration



H-3637



H-3643



H-3645



H-3655



H-3656



H-3635

**Deluxe Slump Cone Set**

ASTM C143, C143M, AASHTO T119, BS1881

The Humboldt, deluxe slump cone set provides you with the basic slump test components in an easy-carry configuration, plus a scoop and funnel to aid in filling the slump cone. The set also includes a specially-designed "crete-brush" with a 20" handle, which stands up to the harsh acids used to clean slump test equipment. The deluxe set includes: H-3636 base plate, H-3638 funnel, H-3639.20 brush, H-3640 slump cone (standard steel), H-3651 tamping rod w/ 6" scale on handle, and a H-3731 scoop and H-4901 tape measure.

**Standard Slump Cone Set**

**H-3635**

Ship wt. 25lbs. (11.4kg)

**Standard Slump Cone Set**

ASTM C143, C143M, AASHTO T119, BS1881

The Humboldt, standard slump cone set provides you with the basic slump test components in an easy-carry configuration. The unique base design allows you to combine the individual components together into a one-piece, portable unit (see photo). The standard set includes our H-3636 cast aluminum base plate, H-3640 slump cone (standard steel), H-3651 tamping rod w/ 6" scale on handle and H-4901 tape measure. The base includes bolt-on clamps, which hold the slump cone securely during filling and rodding. The integral handle, attached to the base, can be rotated above the specimen once the cone has been removed and used as a guide to measure the slump.

**Standard Slump Cone Set**

**H-3637**

Ship wt. 20lbs. (9.5kg)

**Slump Test Set w/ Pan**

ASTM C143, C143M, AASHTO T119, BS1881

This slump cone test set is designed for those who prefer a traditional pan setup. This set includes our H-3640 slump cone (standard steel), the H-3800 wire-bristle, wooden-handled brush, a H-3650 tamping (puddling) rod, the H-3725 galvanized-steel, 24" x 24" x 3" slump pan, and a H-3760 Trowel.

**Slump Test Set w/ Pan**

**H-3645**

Ship wt. 24lbs. (10.9kg)

**K Slump Tester**

ASTM C1362

The K-slump tester provides a fast approximate determination of slump and workability of wet concrete. Can be used to measure slump in buckets, wheelbarrows, ready-mix truck chutes, as well as in-place forms and test molds. The tester is capable of indicating a fairly accurate correlation to an actual slump test. The probe can also be used to determine the workability and the degree of compaction of fresh concrete. Includes correlation chart and instructions.

**K Slump Tester**

**H-3643**

Ship wt. 1.1lbs. (0.5kg)

**Ball Penetration Apparatus (Kelly Ball)**

ASTM C360, AASHTO T183, CTM533

Used to test the consistency of concrete using the penetration of a half sphere into plastic concrete. A 1" (2.5-centimeter) penetration by the kelly ball corresponds to about 2" (5 cm) of slump. The apparatus consists of 30 lb. (14kg) cylinder with hemispherically shaped bottom and handle. Stirrup or frame guides handle act as reference for measuring the depth of penetration. The stirrup handle is graduated in 0.25" (6.4mm) increments on one side and half-centimeter increments on the other side for measuring the depth of penetration. Concrete may be tested as it is placed into forms prior to any manipulation or in a suitable container.

**Ball Penetration Apparatus, 30 lb**

**H-3655**

**Ball Penetration Apparatus, 20 lb.**

**H-3655-20**

Ship wt. 33.7lbs. (15kg)

**Ball Drop Apparatus (Kelly Ball)**

ASTM D6024

Used to test the suitability of load applications on controlled low-strength material (CLSM). Used as a field test to determine the readiness of the CLSM to accept loads prior to adding a wearing surface. Ball and handle weigh 30-33 lbs (14-15kg).

**Ball Penetration Apparatus, D6024**

**H-3655.D6024**



**Carrier for Ball Penetration Apparatus**

Heavy-duty, cast-aluminum design with quick release latches. Provides convenience for the operator and protection to Kelly ball when transporting to and from the job site.

**Carrier for Ball Penetration Apparatus**

**H-3656**



Ship wt. 18lbs. (8kg)





61 \_\_\_\_\_

62 \_\_\_\_\_

63 \_\_\_\_\_

64 \_\_\_\_\_

65 \_\_\_\_\_

66 \_\_\_\_\_

67 \_\_\_\_\_

68 \_\_\_\_\_

69 \_\_\_\_\_

70 \_\_\_\_\_

71 \_\_\_\_\_

72 \_\_\_\_\_

73 \_\_\_\_\_

74 \_\_\_\_\_



\_\_\_\_\_

\_\_\_\_\_

\_\_\_\_\_

\_\_\_\_\_

\_\_\_\_\_

\_\_\_\_\_





**Vebe Consistometer**

EN 12350-3; BS1881:104; UNI 9419

The Vebe Consistometer method is based on the same principle of the simple slump cone test, but it has the advantage of a mechanized action. After removing the slump cone, the concrete undergoes a vibration to determine slump.

- Vebe Consistometer, 120V 60 Hz**      **H-3647**
- Vebe Consistometer, 220V 60 Hz**      **H-3647.2F**
- Vebe Consistometer, 220V 50Hz**      **H-3647.5F**

Ship wt. 199lbs. (90kg)

**Consistency Vibrating Table Test**

ASTM C1170 Method A, C1170 Method B

Used for determining the consistency of stiff to extremely dry concrete mixtures like those used in roller-compacted concrete mixtures. Density of the specimens is determined by determining the mass of the consolidated specimen and dividing by its volume. The unit is comprised of a vibrating table, which can be bolted to a floor or substantial base slab. A swing arm with a guide sleeve for the 50 lb (22.7kg) surcharge weight is attached to the base, which allows the weight to swing out of the way when filling the mold, but allows easy application of the weight to the top of the specimen in the mold prior to vibration. The test mold is 9.5" x 7.75" ID with handles for easy movement and is locked into place on the base with positioning tabs and wing nuts.

- Consistency Vibrating Table, 120V 60 Hz**      **H-3648**
- Consistency Vibrating Table, 220V 60 Hz**      **H-3648.2F**
- Consistency Vibrating Table, 220V 50Hz**      **H-3648.5F**

Ship wt. 360lbs. (150kg)

**Cylinder Mold Vibrating Table Apparatus**

ASTM C1176

Used for making roller-compacted concrete in cylinder molds using a vibrating table. This practice is used when the standard procedures of rodding and internal vibration are not practicable. The unit is comprised of a vibrating table, which can be bolted to a floor or substantial base slab. A swing arm with guide sleeve for the 20 lb (9kg) surcharge weight is attached to the base, which allows the weight to swing out of the way when filling the mold, but allows easy application of the weight to the top of the specimen in the mold prior to vibration. The test mold is a 6" x 12" mold conforming to ASTM C470 and is locked into place on the base of the unit.

- Vibrating Table, 120V 60 Hz**      **H-3649**
- Vibrating Table, 220V 60 Hz**      **H-3649.2F**
- Vibrating Table, 220V 50Hz**      **H-3649.5F**

Ship wt. 305lbs. (138kg)

**Cylinder Molds for Vibrating Table Apparatus**

ASTM C1176, C470 Method B

Standard, disposable, plastic cylinder molds with flat bottoms. For use with H-3649 Vibrating table and H-2950.RCA Mold Sleeves. Easily stripped with stripper tools, sold separately. Oversize charges apply to cartons of 36.

**Plastic Cylinder Molds, 36 per carton**      **H-3041B**

Ship wt. 26lbs. (11.8kg)

**Plastic Cylinder Molds, 20 per carton**

Same as above except that there are 20 molds per carton.

**Plastic Cylinder Molds, 20 per carton**      **H-3041.20**

Ship wt. 15lbs. (6.8kg)

**Mortar Penetration Resistance Apparatus**

ASTM C403, AASHTO T197

Spring-reaction-type apparatus, graduated from 10 to 130 lbf (45 to 580N) in increments of 2 lbf (9N) for testing rate of hardness of mortars sieved from concrete mixtures. Determines effects of variables such as temperature, cement, mixture proportions, additions and admixtures upon the time of setting and hardening of concrete. Penetration resistance is measured by the downward vertical force exerted to penetrate the mortar 1" (25mm). Pressure reading is measured by a scale with a sliding ring indicator on the handle's stem. Includes these interchangeable mortar penetration resistance needles: 1, 1/2, 1/4, 1/10, 1/20 and 1/40 sq. in (645, 323, 161, 65, 32, 16mm<sup>2</sup>).

**Mortar Penetration Resistance Apparatus**      **H-4137**

Ship wt. 16lbs. (9kg)

**Resistance Needle Set**

ASTM C403, AASHTO T197

Set of six, screw-on type, replacement needles for use with the H-4137 mortar penetration resistance apparatus. Set includes all needles in chart below. Needles are also available individually.

**Resistance Needle Set**

**H-4143**

Ship wt. 0.5lb (1.0kg)

Description	Part No.
1 sq. in. (645mm <sup>2</sup> )	H-4143.1
1/2 sq. in. (323mm <sup>2</sup> )	H-4143.50
1/4 sq. in. (161mm <sup>2</sup> )	H-4143.25
1/10 sq. in. (65mm <sup>2</sup> )	H-4143.10
1/20 sq. in. (32mm <sup>2</sup> )	H-4143.05
1/40 sq. in. (16mm <sup>2</sup> )	H-4143.025





Remote Monitoring Example of HG-4040A



**Humboldt Concrete Maturity Sensor System**  
ASTM C1074

Humboldt’s Maturity Sensor System provides an innovative way to monitor concrete strength using the maturity testing method. CMOTS provides a wireless, accurate, durable and reusable method for charting concrete temperatures, maturity and strengths, which allows constant monitoring from any device (computer, phone or tablet) with an Internet connection.

CMOTS is ideal for monitoring maturity in massive concrete pours, walls, suspended slabs and pavements, as well as for footings, cylinders and beams for monitoring compliance with curing requirements. The Humboldt Maturity System provides a wireless solution to collecting data avoiding loss of data due to cable damage during construction activities. Temperature and compressive strengths can be accessed from anywhere without visiting the construction site. And, the system is very cost effective when compared to other semi-wireless systems.

The system includes three key components—a transmitter, sensor and receiver. The sensor is connected to the transmitter with a waterproof connection via a 20ft. (6m cable). The sensor is then embedded at a desired location within a concrete pour. The attached transmitter is then placed alongside the pour and can be secured, if desired. The wireless receiver is then located within 1000 ft (300m) of the furthest installed transmitter/sensor.

When the sensors are installed, they are activated by registering them with your website account using a sensor-specific ID number. Once this step is completed, the transmitters for each sensor will begin to receive data from the sensor and transmit that data to the receiver. The receiver then relays this information to your account on the web-based cloud platform. This information/data is available to you in real time, 24/7, 365 days a year by simply logging into your account, using your user name and password.

Raw data received by your sensors is transformed by the web-based platform into compressive

strength, using the specific maturity curve developed for that specific concrete mix design.

Because the maturity sensor system is wireless, there is no limit to the number of sensors that can be used or the number of pours done at one time. The transmitter component of this system is reusable, battery life is 3 years from the activation date, it can be reused by purchasing replacement sensors for subsequent uses, which can be connected to the existing transmitters via the waterproof connector. Sensors are available with 20ft (6m) cables, but extension cables are also available in similar lengths for extended sensor placement.

The Maturity Sensor System is available as a kit, which includes (1) Receiver, (5) Transmitters, (5) Sensors with 20ft (6m) cables and a website platform account. Voltage: 120/220V 50/60Hz.

**Humboldt Maturity Sensor System H-2683.3F**

Ship wt. 8.9lbs. (4kg)

**Humboldt Maturity Sensor System Components**

Description	Part No.
Temperature Transmitter w/20ft (6m) cable	H-2683.4
Sensor w/ 20ft (6m) cable	H-2683.6
Extension Cable, 20ft (6m)	H-2683.7

**SmartRock™, Wireless Maturity Sensor**

ASTM C1074 (Approved by ACI 318, CSA A23.1, most USDOT specifications)

SmartRock™ is the world’s leading wireless sensor for monitoring concrete curing and hardening. This fully embedded sensor attaches to rebar using a built-in strap for hassle-free installation. SmartRock™ collects temperature data from two points independently: (i) the probe at the tip of the cable and (ii) from inside the sensor body. Calculate in-place concrete strength automatically using the maturity method (ASTM C1074). Your results and your temperature data are always accessible remotely and in real time via the free SmartRock™ mobile app and the Giatec 360 dashboard.

**Benefits:**

- Measure temperature differentials in mass concrete
- Optimize curing conditions
- Accelerate form-work removal and post-tensioning
- Control quality in the field
- Open roads to traffic and finish tilt up construction sooner

**Features (Hardware):**

- Wireless technology
- Rugged and waterproof design
- Easy installation and activation
- Extended temperature sensor cable for mass concrete
- Long battery life (up to 4 months after installation)

**Features (Software):**

- Free mobile app for Android/iOS
- Project management tools, including live data sharing
- Smart alerts and notifications
- AI analysis of concrete pouring time and mix calibration errors with Roxi™

**SmartRock™ Maturity Sensor, 12" HG-4040A**

**SmartRock™ Maturity Sensor, 10ft (3m) HG-4040A.10**

Ship wt. 1lbs. (0.4kg)

Specifications	
Reading Range	-22 to +181°F (-30 to 85°C)
Measurement Accuracy	± 1.8 °F (± 1°C)
Measurement Resolution	± 1.8 °F (± 0.1°C)
Measurement Frequency	Once every 15 mins.
Wireless Signal Range	Up to 40 feet (up to 12 m)*
Temperature Cable Length	12 in (30 cm) / 10 ft (3 m) / By request: 50 ft (15.2 m)
Data Formats	Export as PDF or CSV
Battery Life	Up to 4 months

\* Following installation depth requirements.





00005

00005

00005

00005

00005



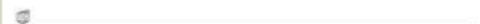
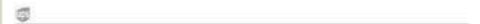
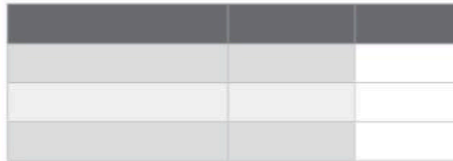
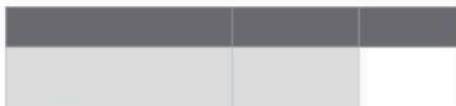
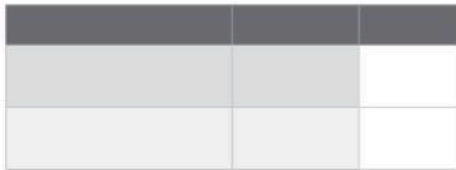
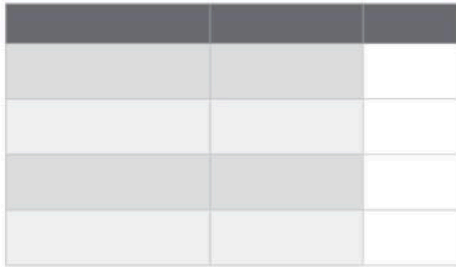
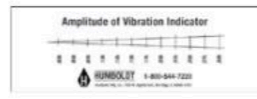
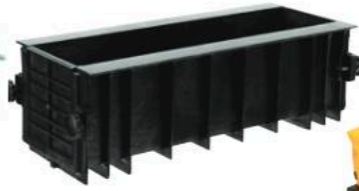



H-3041B



H-3037PML



H-3650

H-2905.1



H-3041LB



H-3041S

H-3041SMA



H-3046



H-3045



Watch the Video Now!

**Concrete Cylinder Molds, Single-use, Plastic**

C31, C39, C192, C470, C496; AASHTO T22, T23, T126, T198, M205

Disposable, plastic cylinder molds with flat bottoms. Easily stripped with stripper tools (order separately).

Size	Description	Ship wt.	Model
6" x 12" (152 x 305mm)	Reinforcing rib around top opening. Lids not included. Cartons of 36, oversize UPS charges apply.	26 lbs. (11.8kg)	H-3041B
6" x 12" (152 x 305mm)	Reinforcing rib around top opening. Lids not included. Cartons of 20	15 lbs. (6.8kg)	H-3041.20B
6"Ø (152mm)	Plastic lid for use with H-3041B mold. Sold individually.	0.08 lbs. (.04kg)	H-3041LB
4" x 8" (102 x 203mm)	Complete with integral, domed plastic lid. Cartons of 36, oversize UPS charges apply.	14 lbs. (6.3kg)	H-3037PML
3" x 6" (76 x 152mm)	Complete with integral, domed plastic lid. Cartons of 80, oversize UPS charges apply.	16.4 lbs. (7.4kg)	H-3038PML
2" x 4" (51 x 102mm)	Complete with integral domed plastic lid. Cartons of 84.	5 lbs. (3.6kg)	H-3039P

**Tamping (Puddling) Rod**

Round, straight steel rod measures .625" (16mm) dia. x 24" (610mm) long. Both ends rounded. Plated for rust resistance.

**Tamping (Puddling) Rod** **H-3650**  
 Ship wt. 4.3lbs. (1.9kg)

**Tamping Rod**

ASTM C157, C192

Round, straight steel rod measures .375" (10mm) dia. x 12" (305mm) long. Both ends are rounded to a hemispherical tip of the same diameter as the rod.

**Tamping Rod** **H-2905.1**  
 Ship wt. 4.3lbs. (1.9kg)

**Mold Strippers**

Mold strippers split single-use plastic cylinder molds for cylinder removal.

**T-Handle Style** **H-3041S**  
**Screwdriver Style** **H-3041SMA**  
 Ship wt. 2lbs. (0.9kg)

**Quick-Strip Mold Strippers**

The Quick-Strip Mold Stripper from Humboldt provides fast, easy and safe stripping of cylinder molds with one easy pull of its lever. With each pull of the lever the Quick-Strip slices plastic cylinder molds with two opposing cuts, making removal of the concrete cylinder easy. And, since the Quick-Strip is designed to be bench mounted, it will also save your lower back from bending over to strip molds on the floor like you do with conventional stripping tools. The Quick-Strip also doesn't bottom out the knife blades when it cuts molds, so you'll save on the frequency of blade replacements. And, you'll save wear and tear on your floors, which are often ruined by repeated blade gouging.

- No more bending over molds on the floor
- No more missed hammer blows
- No more stripping tools slipping off the mold
- No more floor gouging

The Quick-Strip will provide you with cylinder mold stripping that's faster, safer and more efficient, especially when you have large numbers of cylinders to process.

Video: <https://youtu.be/WUTRdgNu-24>

**Quick-Strip Mold Stripper, 4" x 8"** **H-3045**  
 Ship wt. 75lbs. (34kg)

**Quick-Strip Mold Stripper, 6" x 12"** **H-3046**  
 Ship wt. 75lbs. (34kg)

**Replacement Blade for Strippers** **H-3046.1**  
 Ship wt. 1lbs. (1.9kg)



H-3046.1







		+	
		+	
		+	









H-2943



H-2977C



H-2977S.6  
H-2977S.12



H-2970.1



H-2970A



H-2969.6

**Sample Cart, Welded**

Premium-grade all-welded cart has 800-lb. capacity. Features 5 x 1-1/4" casters mounted to cross-channel bolster plate for added support, convenient offset handle and 36" x 24" (914 x 609mm) tray size. Smooth finish; no rough edges. Shipped assembled.

**Sample Cart, Welded** **H-2943**

Ship wt. 75lbs. (34kg)

**Sample Cart, Bolt-Together**

For use in handling concrete beams and cylinders, plus soil and aggregate samples in the lab or field. Ready to assemble. Cart has pan-type rolled-edge 3-1/2" (89mm) deep steel shelves. Top shelf reverses to flat working surface. Features 5" (127mm) dia. rubber casters; front casters swivel for easy steering. Dimensions: 24" x 36" x 32" (61 x 91 x 81cm). Assembly required.

**Sample Cart, Bolt Together** **H-2944**

Ship wt. 55lbs (25kg)

**Carrying Rack for Concrete Cylinders**

Carrying rack for 4" x 8" test cylinders. Durable, molded plastic construction with molded handles for easy and safe transportation. Easily carry 8 cylinders at a time in this plastic carrier, which will not deteriorate or corrode in water. Allows you to keep companion cylinders together in the same case for curing.

**Carrying Rack for Concrete Cylinders** **H-2977C**

Ship wt. 4.5lbs. (1.8kg)

**Curing Rack for Concrete Cylinders**

Durable, plastic cylinder curing racks provide a stable and open air flow design for storing cylinders during curing. The racks are manufactured from recycled plastic materials to resist moisture, abrasion, as well as chemical and temperature variations. Each rack has built-in handles for easy carrying. Each rack holds (4) 4" x 8" cylinders and the interlocking racks can be stacked 12 high (58").

**Curing Rack for Cylinders (6 racks)** **H-2977S.6**

Ship wt. 7 lbs (3.2kg)

**Curing Rack for Cylinders (12 racks)** **H-2977S.12**

Ship wt. 27.1lbs. (12.2kg)

**Transport Rack for 6" Test Cylinders**

Test cylinder transport rack securely holds (8) 6" x 12" cylinders in a lightweight and durable frame, which can be secured to a truck bed or used in conjunction with the H-2970A field curing chest listed below. Open center position is available for heater. Will not rot or rust. Rack is 23.5" square by 9" high.

**Transport Rack for 6" Test Cylinders** **H-2970.1**

Ship wt. 11.2lbs. (5.1kg)

**Transport Rack for 4" Test Cylinders**

Test cylinder transport rack similar to above, but securely holds (16) 4" x 8" cylinders. Rack is 23" square by 7" high.

**Transport Rack for 4" Test Cylinders** **H-2970.2**

Ship wt. 15lbs. (6.8kg)

**Field Curing Chest**

The field curing chest offers the user with an affordable approach to store, transport and cure concrete test cylinders. The chest consists of a 24" x 24" x 14" (610 x 610 x 356mm) zipper-sealed polymer and vinyl chest with 0.5" (12.7mm) insulating foam. The unit can accept up to nine 6" x 12" concrete cylinders.

**Field Curing Chest** **H-2970A**

Ship wt. 13.6lbs. (6.18kg)

**Poly Curing Tanks**

Durable seamless design resists breakage. All round-end tanks have an extra heavy duty, molded rim and an extra-deep sidewall rib design for additional strength. Heavy duty, molded-in aluminum drain fitting and 1.25" poly drain plug ensure a long-life. Tested to -20° F, corrosion-free impact resistant and recyclable. Premium UV protection assures long life and resistance to color fade in outdoor use. Shipping weights: 8': 66lbs (29kg); 6': 49lbs (22kg); 4': 30lbs. (13.6kg).

**Poly Curing Tank, 3' x 2' x 8'** **H-2969.8**

**Poly Curing Tank, 2' x 2' x 6'** **H-2969.6**

**Poly Curing Tank, 2' x 2' x 4'** **H-2969.4**

Ship wt. see above





63

64

65

66

67

68



12

12

12

12









H-2742



VaporPlus Curing Room System

**Tri-Breeze Curing Room System Sanitizer**

The Tri-Breeze Curing Room System Sanitizer is a sanitizing system designed for use with the VaporPlus Curing Room System. It provides proven sanitizing capabilities to disinfect against a build up of bacteria and viruses. It kills pathogens on contact and converts to regular oxygen, leaving no toxic residuals. It has been proven to be effective against Listeria, Salmonella, E. Coli, Norovirus, Campylobacter and other pathogens. The system generates oxygen (O<sub>2</sub>) in a relatively simple process using ordinary air. Oxygen and Nitrogen are the raw materials. As the air is drawn through the reaction chamber, energy is supplied, which splits some oxygen molecules into oxygen atoms. Some of these atoms then quickly react with oxygen molecules to form an activated oxygen. This process cleans and sanitizes the system more effectively and less expensive than a chlorine-based system.

Tri-Breeze, Sanitizing System, 120V 60Hz H-2742

Tri-Breeze, Sanitizing System, 220V 50/60Hz H-27424F

Ship wt. 30lbs. (13.6kg)



**Replacement Parts for H-2741 VaporPlus**

Description	Part No.
Spray Nozzle	H-2741.1
Air Filter Cartridge	H-2741.2
Air Muffler Filter (Qty. 4)	H-2741.3
10" Sediment Cartridge	H-2741.4
10" KDF Media Cartridge	H-2741.5

Uses standard 1/4" tubing.

**Monitor the VaporPlus System with Humboldt's NEW Concrete Humidity Sensor System!**



**Humboldt Concrete Humidity Sensor System**

Based on Humboldt's Concrete Maturity System, the Humidity Sensor System can be used to wirelessly monitor curing room humidity.

The Humboldt Humidity Sensor System provides a wireless solution to collecting humidity data. Humidity can be accessed from anywhere without even visiting the curing room. When the system is installed, it is activated by registering it with your website account using a sensor-specific ID number. Once this step is completed, the transmitter for each sensor

will begin to receive data from the sensor and transmit that data to the receiver. The receiver then relays this information to your account on the web-based cloud platform. This information/data is available to you in real time, 24/7, 365 days a year by simply logging into your account, using your user name and password. See page 170 for additional information.

The Humidity Sensor System is available as a kit, which includes (1) Receiver, (1) Transmitter/Sensor, and a website platform account.

**Humboldt Humidity Sensor System H-2689.3F**

Ship wt. 8.9lbs. (4kg)





**Temperature/RH Loggers**

These temperature and relative humidity data loggers are housed in a robust, waterproof (IP68-rated) case, which is designed for use in harsh applications like cylinder curing rooms. They are available with an integral, coated RH sensor (H-2736) or with a temperature and relative humidity probe with a 1.5m cable length (H-2732). The relative humidity probe features a coated RH sensor that shows good resistance to moisture and condensation, ensuring measurement reliability. These data loggers have a high reading resolution and accuracy and provide fast off-load speed and a low battery monitor. Data is downloaded to a computer for viewing, reports and archiving. Data stored on the logger will be retained after a battery is replaced. See tables below for specific logger specifications. Require H-2736, SW software and a download cable for operation. Dimensions: 1.75" x 2.25" x 3.15" (34 x 57 x 80mm).

Logger Specifications	
Reading Capacity	32,000
Memory Type	Non-volatile 64K
Reading Types	Actual, Min, Max
Delayed Start	Relative / Absolute (up to 45 days)
Trigger Start	Magnetic Switch (H-2736.3)
Alarms	2, fully programmable
Stop Options	When full, After "n" Readings, Never overwrite oldest data
Operating Range	-40°F to +185°F -40°C to +85°C
Battery	User-replaceable Lithium

Temperature Specifications	
Sensor	10K NTC Thermistor
Range	-13 to 185°F (-25 to 85°C)
Response Time	25 mins to 90% FSD in moving air
Accuracy	0.01°C or better

Relative Humidity Specifications	
Sensor Type	Capacitive
Reading Range	0 to 100% RH
Accuracy	±3.0% at 77°F (25°C)
Reading Resolution	Better than 0.3% RH
Sensor Location	Externally mounted
Response Time	10 seconds to 90%

Temperature/RH Logger **H-2736**  
 Temperature/RH Logger with Probe **H-2732**  
 Ship wt. 0.3lbs. (.13kg)

**Temperature/RH Logger Software**  
 Explorer Software for operating H-2736 and H-2732 data loggers. This Windows-based program is simple and intuitive to use, allowing users to easily manage both Tinytag loggers and recorded data. A simple to use launch page that allows easy editing of a data logger's settings, while at the same time summarizing them clearly. When offloaded, recorded data is initially presented as a graph but can also be displayed as a table of readings if required. These views are supplemented with an information view, that summarizes details of the data being shown, and a daily minimum/maximum view. Data can easily be exported from all four views into MS Excel and Word, either as a file or by simply copying and pasting. The software supports multiple languages, and there is also a comprehensive, illustrated help file to take the user through the basics of the software, and its more advanced features. Site licenses are available for multiple installs.

Temperature/RH Logger Software **H-2736SW**  
 Ship wt. 1lbs. (.45kg)

**Logger Download Cables**  
 Download cables to connect a PC to the H-2732 and H-2736 Loggers.

Download Cable, Serial **H-2736.1**  
 Download Cable, USB **H-2736.2**  
 Ship wt. 0.5lbs. (.22kg)

**Trigger Start Magnet**

A magnet for starting loggers that have been set up for a trigger start.

Trigger Start Magnet **H-2736.3**  
 Ship wt. 0.1lbs. (.04kg)

**Stevenson-type Screen Enclosure**

The Stevenson-type screen, or instrument shelter, shields data loggers against precipitation and direct heat radiation from outside sources, while still allowing air to circulate freely around it.

Stevenson-type Screen Enclosure **H-2736.4**  
 Ship wt. 1.5lbs. (.68kg)

**Automatic Cylinder End Grinder**

ANSI/ASTM C39  
 No capping material is required to finish the specimen end. Grinding disks typically finish 3,000 - 5,000 pieces before replacement is necessary. The unit is safe and economical. This unit comes with accessories for grinding 3" (75 mm), 4" (100 mm), and 6" (150 mm) cylinders. Other sizes can be finished using an optional jig, please inquire. Fragile or low strength materials can be finished satisfactorily. The automatic cylinder feeding decreases skills needed for operation while further increasing safety. The end grinder is conveniently mounted on lockable castors providing easy mobility, and is relatively small in size, so storage space is kept to a minimum.

H-2956A Specifications	
Sample Size	6" x 12" (152 x 305mm) cylinder 4" x 8" (102 x 203mm) cylinder 3" x 6" (75 x 150mm) cylinder sold separately H-2956.8
Cut Precision	Plane and Parallel to within 0.002" (.05 mm)
Cutting Feed	Manual—right hand operation
Cutting Head	Diamond wheel
Cutting Speed	60 to 120 seconds per end
Dimensions	53" x 33.5" x 24" (1350 x 850 x 600mm)





HC-2979.2F.3  
HC-2979.5F.3

- Grinds planeness and parallelism of test cylinder ends
- Planeness Accuracy: 0.002" (0.05mm)
- Grinding Time: 90 to 120 seconds per end
- Ready to use for 6" x 12" (150mm x 300mm), 4" x 8" (100mm x 200mm) test cylinders
- Easy access to water inlet and outlet
- Diamond-grinding wheel included

#### Automatic Cylinder End Grinder H-2956A

Ship wt. 400lbs. (180kg)

#### 3X6 Jig Attachment with Plastic Plate for H-2956A

Grinder attachment with plastic plate for grinding 3x6" cylinders with the H-2956A grinder.

#### 3X6 Jig Attachment with Plastic Plate H-2956.8

Ship wt. 18 lb (8.2kg)

#### Grinding Wheel, Replacement

Replacement grinding wheel for the H-2956 Specimen Grinding Machine.

#### Grinding Wheel, Replacement H-2956.6

Ship wt. 25 lb (11.3kg)

#### Automatic Grinding Machine

ASTM D4543, C31, C39, C192, and C617

This automatic grinding machine is designed to grind and polish concrete cubes, cylinders, blocks, natural stones, rocks and ceramic materials. Specimens are easily fixed to the table with the use of the proper locking stirrups. See chart for specimen types and sizes.

This unit features a grinding head is equipped with an end-of-stroke system, which allows full automatic displacement in both directions without activating the electric pushbutton. This unit is designed for the simultaneous grinding of varied types of specimens, including concrete cube, cylinders, blocks and rock. It offers the motorized radial displacement of the abrasive head in both directions. The revolving abrasive head is radially and alterna-

tively moved in both directions through an electric motor actuated by push button. The column is completely protected against abrasive dust. The grinding head can be lowered vertically in 0.05mm graduations by using the top handwheel. The machine is made from rugged plate and is supplied complete with: control panel; coolant/decantation tank for water and emulsifying oil; motor pump; set of standard abrasive sectors; safety chip guard that automatically stops the machine if it is removed. Both models are 3-Phase electric.

#### HC-2979 Specifications

Specimen Size	6" x 12" (152 x 305mm) cylinder 4" x 8" (102 x 203mm) cylinder 3" x 6" (75 x 150mm) cylinder 6" Cubes 100mm, 150mm, 200mm Cube 390 x 250mm Block
Table Dims.	30.5" x 11.0" (775 x 280mm)
Head Stroke	8.5" (215mm)
Wheel Dia.	13" (330mm)
Wheel Speed	1400rpm
Power Supply	240V, 3ph 4500W
Dimensions	48" x 42.5" x 68" (W x D x H) (1220 x 1080 x 1730mm)

Specimen Grinder, 240V, 60Hz-3PH HC-2979.2F.3

Specimen Grinder, 240V, 50Hz-3PH HC-2979.5F.3

Ship wt. 904lbs. (410kg)

#### NOTES

HC-2979 Grinding Machine includes Standard Abrasive Grinding Sections, but require the separate purchase of specimen locking devices, not included. Choose between the Fast Locking Device or the appropriate Locking Stirrups for your operation.

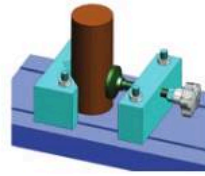

HC-2980.1

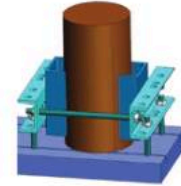

HC-2980.2, HC-2980.3

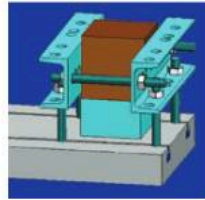

HC-2980.3

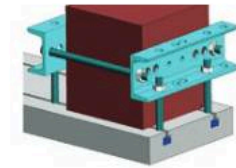

HC-2980.4

#### Standard Abrasive Grinding Sections

Standard abrasive grinding sections provide excellent grinding capabilities and long life.

Sold as a set of 8.

#### Standard Abrasive Grinding Sections HC-2980.5

Ship wt. 20 lb (9.1kg)

#### Diamond Grinding Sections

Diamond grinding sections provide enhanced grinding capabilities and long life.

Sold individually, 8 required.

#### Diamond Grinding Sections HC-2980.6

Ship wt. 20 lb (9.1kg)

#### Fast Locking Device

Fast locking device for use with Cubes 150 and 200mm; Cylinders 100 to 160mm. Each device accepts only one specimen. It is possible to grind (1) 200mm cube, (2) 150mm cubes or (2) cylinders.

#### Fast Locking Device HC-2980.1

Ship wt. 25 lb (11.3kg)

#### Locking Stirrups, Cylinders

For use with cylinder specimens, 4" x 8" and 6" x 12", 100mm, 150mm. Complete with 60mm high spacer. Note: must be used in conjunction with HC-2980.3 for proper operation, order separately.

#### Locking Stirrups, Cylinders HC-2980.2

Ship wt. 25 lb (11.3kg)

#### Locking Stirrups, Cubes

For use with cube specimens, 100mm, 150mm and 200mm. Complete with 60mm high spacer.

#### Locking Stirrups, Cubes HC-2980.3

Ship wt. 25 lb (11.3kg)

#### Locking Stirrups, Block

For use with block specimens 390mm x 250mm.

#### Locking Stirrups, Block HC-2980.4

Ship wt. 25 lb (11.3kg)





HC-2931.2F



HC-2930

Shown with optional adjustable stand (sold separately).



HC-2933, HC-2935



HC-2932, HC-2934

MASONRY SAW ACCESSORIES

Masonry Saw, 8" Cut

Saw for use in cutting cylinders and blocks. Blade capacity is 20" (508mm), which allows a cutting depth of 8" (203mm). Unit features a 5hp, 230 60hz 1ph Baldor motor. The saw has only two pivot points for reduced saw maintenance and longer diamond blade life. The cutting head pivots on bearings, which are sealed and lubricated for life requiring no greasing. Its ergonomically designed steel handle with molded grip bolts securely into place and the Sta-level® blade guard keeps the blade guard parallel to the cutting table for accurate cuts. Height can be controlled with a convenient crank control on foot pedal.

Blade not included, order separately.

- High torque, continuous duty dual capacitor motors make efficient use of horsepower and reduce cutting time.
- Capable of cutting 8" x 8" x 16" block with a 20" blade in one pass or 10" block with a 24" blade in one pass. (For 24" blade, please inquire)
- Height can be controlled with a convenient crank control or foot pedal.
- The Sta-level® blade guard keeps the blade guard parallel to the cutting table for accurate cuts.

HC-2931 Specifications	
Blade Dia.	20" (508mm)
Cut Depth	8" (203mm)
Motor	5hp (3.7)
Power Supply	230V, 1ph
Dimensions	47.75" x 22" x 57.5" (1213 x 559 x 1461kg)
Weight	361 lbs. (162kg)

Masonry Saw, 230V, 60Hz HC-2931.2F

Ship wt. 361lbs. (162kg)

Masonry Saw, 5" Cut

Saw for use in cutting concrete and mortar cylinders and blocks. Blade capacity is 14" (350mm), which allows a cutting depth of 5" (127mm). Perfect for cutting 4"x 8" cylinders. Unit features a 1.5hp, 115V 1ph . The saw has only two pivot points for reduced saw maintenance and longer diamond blade life. The cutting head pivots on bearings, which are sealed and lubricated for life requiring no greasing. Its ergonomically designed steel handle with molded grip bolts securely into place and the Sta-level® blade guard keeps the blade guard parallel to the cutting table for accurate cuts. Height can be controlled with a convenient crank control on foot pedal.

- Equipped with a patented water management system that keeps the work piece dry and the workplace clean.
- The double splash guard decreases water spray behind the saw and makes cleaning easier.
- Head rotates to easily cut 22.5 degree and 45 degree bevel cuts.
- It is easy for two people to move the saw thanks to integrated telescopic handles.
- Sta-level® blade guard keeps the blade guard parallel to the cutting table for accurate cuts.

HC-2930 Specifications	
Blade Dia.	14" (356mm)
Cut Depth	5" (127mm)
Motor	1.5hp (1.1)
Power Supply	115/60 hz
Dimensions	39.8" x 26.4" x 25.6" (1010 x 670 x 650mm)
Weight	131 lbs. (59kg)

Masonry Saw, 120/230V, 60Hz HC-2930

Ship wt. 171lbs. (77kg)

Masonry Saw Elite Cut (Silent Core) Blade

High-quality, fast cutting, silent core blade designed for abrasive, lightweight block. Designed for dry or wet cutting. The segment height is .500" (400" diamond depth and 1.00" segment base).

Masonry Blade, 20" (508mm) x .140" x 1" HC-2933

Masonry Blade, 14" (350mm) x .125" x 1" HC-2935

Ship wt. 15lbs. (6.8kg)

Masonry Saw Blade, Elite Cut

High-quality, fast cutting, blade designed for abrasive, lightweight block. Designed for dry or wet cutting. The segment height is .500" (400" diamond depth and 1.00" segment base).

Masonry Blade, 20" (508mm) x .140" x 1" HC-2932

Masonry Blade, 14" (350mm) x .125" x 1" HC-2934

Ship wt. 15lbs. (6.8kg)

Portable Masonry Saw Stand

Portable, adjustable stand for HC-2871 Masonry Saw. Stand is easy to set up and take down and is adjustable to several heights for user comfort. It easily folds down to serve as a dolly to transport or store saw. Folded dimensions are: 22" x 42" x 12" (559 x 1067 x 305mm)

Portable Masonry Saw Stand HC-2930.1

Ship wt. 40lbs. (18.1kg)







13

13

13

13

13





**Cylinder Capping Kit**

ASTM C31, C39, C192, C617; AASHTO T22, T23, T126, T231

Kit provides the basic components for cylinder capping and includes: (1) H-2945 cylinder carrier, (1) H-2952 vertical cylinder capper, (1) H-2953 compound melting pot, (1) H-2959 capping compound and (1) H-2958 ladle. See individual components for descriptions.

Cylinder Capping Kit, 120V 60Hz **H-2951**

Cylinder Capping Kit, 220V 50/60Hz **H-2951.4F**

Ship wt. 130lbs. (58.7kg)

**Capping Ladle**

ASTM C07, C386, C617

Stainless steel ladle with 4" (102mm) dia. bowl is used in transferring capping compound from melting pot to capping fixture.

Capping Ladle **H-2958**

Ship wt. 1.3lb (0.6kg)

**Capping Compound, Flake-Style**

ASTM C307, C321, C386, C579, C617, D71

50 lb bag of Sauereisen No. 600 sulfur-based, flake-form capping compound melts and sets within minutes. Silica-filled compound has 150 psi bond strength, 9000 psi compressive strength and 605 psi tensile strength. Compound pours between 265 and 290°F (129 to 143°C). Overheated material's viscosity is reinstated by decreasing temperature to 290°F.

Capping Compound, Flake-Style **H-2955**

Ship wt. 52lbs. (24kg)

**Hydrocal White Gypsum Cement**

Used as capping compound. USG Hydrocal Brand White Gypsum Cement is a good multi-purpose product for people looking to upgrade from a standard plaster product to one that has a higher degree of hardness and impact resistance. Offering twice the compressive strength of plaster, Hydrocal® White Gypsum Cement is especially suitable in thin, delicate sections where high green strength is required. 50 lb. bag. Meets ASTM C617.

- Offers long workability; setting expansion twice that of molding plaster and pottery plaster
- Has a great value to performance ratio
- Sets 25-35 minutes after machine mixing
- Requires 45 parts water by weight per 100 parts plaster.
- Compressive Strength, One Hour After Set 3000 psi (20.7 MPa)
- Compressive Strength, Dry 6000 psi (41.4 MPa)

Hydrocal White Gypsum Cement **H-2959H**

Ship wt. 52lbs. (24kg)

**Hydro-Stone® Gypsum Cement**

Exceptionally strong gypsum cement is a multi-purpose product used as a high strength alternative to sulfur capping compound. High water absorption resistance. 50 lb. bag. Meets ASTM C617.

- Sets in 17-20 minutes, after machine mixing
- Requires 32 parts water by weight per 100 parts plaster.
- Compressive Strength, One Hour After Set 4000 psi (27.6 MPa)

Compressive Strength, Dry 10,000 psi (68.9 MPa)

Hydro-Stone® Gypsum Cement **H-2959HS**

Ship wt. 52lbs. (24kg)

**Compound Melting Pots**

ASTM C617; AASHTO T231

Designed for melting capping compound, paraffin and similar materials; compound melting pots feature an adjustable thermostat to deliver close temperature control automatically from 100° to 320°F (37.8 to 160°C). Includes cover, pilot light, 6' (1.8m) 3-conductor grounded cord set. Inner pot is cast aluminum encased in a metal jacket with fiberglass and air insulation, keeping heat loss to a minimum. Replaceable heating elements are securely clamped to the bottom and sides of the crucible for even heat distribution.

Capacity	Electric	Amps	Ship wt.	Model
4 qt.	120V 60Hz	6	16.8 lbs	H-2953
3.8L	220V 50/60Hz	3	18 kg	H-2953.4F
8 qt.	120V 60Hz	10	20 lbs	H-2954
7.6L	220V 50/60Hz	5	29 lbs	H-2954.4F
12 qt.	120V 60Hz	11	31 lbs	H-2955
11.4L	220V 50/60Hz	5.5	31.1 lbs	H-2955.4F
20 qt.	120V 60Hz	12	48 lbs	H-2948
19L	220V 50/60Hz	6	43.6 lbs	H-2948.4F
28 qt.	120V 60Hz	15	48 lbs	H-2949
26.5L	220V 50/60Hz	7.5	48 lbs	H-2949.4F

Compound Melting Pots **see chart above**

Ship wt. see chart above





Tests 6:48 AM ID 1

PREVIOUS TESTS CURRENT TESTS [TEST\_1]

INPUT 1 LOAD

19375

STRESS 1542 RATE 283

TEST CONTROL

Input 1 Calibration 2:24 PM ID 44

SENSOR DETAILS | POINTS 3. MULTI POINT

Create Multi-Point Calibration:  
Please note a minimum of 2 points are required for a successful calibration.

POINT	APPLIED	A/D COUNTS
0	0	12852
1	50000	74401
2	100000	35649
3	150000	38348
4	200000	42120
5	250000	50520
6	0	0
7	0	0
8	0	0
9	0	0
10	0	0

Entry Method  
 QUICK CLICK  
 MANUAL ENTRY

Calibration  
Custom

Clear Point

Test Setup Wizard 9:55 AM ID 1

Select Test Type:  
Please select the type of test you will be running.

ASTM  C39 BS  EN 12390-3

- C78
- C293
- C469
- C496
- C1019
- C109/C109M









HCM-720

## Automate your existing compression frame

Looking to automate your existing compression machine? Now you can easily upgrade it with one of Humboldt's automatic compression machine controllers — the HCM-5080 or the HCM-5070. Both controllers come with our robust, reliable and cool-running 1hp pump, which works together with the controller for full operational control of your compression machine. Both are pre-programmed to run the following tests: ASTM C39, ASTM C78, ASTM C293, ASTM C469, ASTM C496, ASTM C1019, ASTM C109/C109M, BS EN 12390-3.

The HCM-5080 upgrade kit comes with the necessary brackets and mounting hardware and both controllers are available with new compatible transducers, making these upgrade kits a quick and easy upgrade.

Don't want an automated controller? You can also upgrade your machine with the HCM-5090 digital indicator and use your existing pump or add one of our manual pumps as well. The HCM-5090 is also pre-programmed to run all the tests listed above.

### Upgrade/Retrofit Accessories for HCM-5090

Pressure Transducer, 10,000 psi with Cable and Plug	HCM-4177
Pressure Transducer, 10,000 psi	HCM-4177.1
Cable for Pressure Transducer with Plug	HCM-4177.4

### HCM-5090 Digital Indicator

ASTM C39, C78, C293, C469, C496, C1019, C109/C109M; BS EN 12390-32

Humboldt's HCM-5090 digital indicator provides the same platform and many of the same features as the HCM-5080 and HCM-5070 except that it does not act as a controller, but works with a manually-operated pump.

#### Features:

- Provide two channel inputs for load, which allows for the control of two separate compression frames
- Provides two additional channel inputs for displacement, which allows performing extensometer and compressometer testing
- 7", high-resolution color touch-screen display with live readout, graphical and tabular display
- Easy test setup, just choose the standard you wish to test for and the controller will walk you through the complete setup
- Provides data acquisition of one reading per second
- Integral storage within the controller of up to 1000 tests and 3000 points per test
- Simple, Fast and accurate machine calibration
- Displays in Imperial or metric numbers
- Pre-programmed to run the following tests: ASTM C39, ASTM C78, ASTM C293, ASTM C469, ASTM C496, ASTM C1019, ASTM C109/C109M, BS EN 12390-3

The HCM-5090 is also available as a retrofit package.

Humboldt Digital Indicator **HCM-5090.3F**  
 CE Ship wt. 13 lbs. (5.9kg)

### HCM-720 Digital Indicator

ASTM C39, E4, AASHTO T22

The i7 is an easy-to-use digital load indicator that simultaneously displays both live load and rate of load values during a test. It eliminates the need to toggle keys between functions, and, automatically displays peak load and average rate of load at the end of each test.

All test information is clearly displayed on the indicator's 5.3" (135 mm) wide 240 x 64 pixel backlit V.G.A., liquid-crystal display with adjustable contrast settings. Test data is displayed in user selectable engineering units of lbs, kN, kg and N with rate of load displayed in force units per second.

The indicator will store up to 600 tests in memory, and transfer them directly into a word document via the optional USB Able Cable, or print them on an optional serial printer. Stored test data includes; test date and time, sample ID number, peak load and average rate of load. The average rate of load calculation is based on the average load rate applied to the sample during the second half of the test.

The i7 is also available as a retrofit package.

HCM-720 Digital Indicator **HCM-720**  
 CE Ship wt. 13 lbs. (5.9kg)





HCM-0030iH  
Shown with Optional  
Flexural Attachment  
for Beams.



HCM-1000iH



HCM-2500iHA

**HCM-0030 Series Compression Machines**

ASTM C39, E4, AASHTO T22

- Suitable for beams of standard strength concrete mixes
- 300 to 30,000 lbf (1.3 to 113.5kN) testing range with accuracy of  $\pm 0.5\%$  of indicated load
- Standard configuration includes no platens. Order HCM-0119B for beam testing
- Choice of two digital controllers and two digital indicators (see page 187-189)
- Optional test platens and accessories available on pages 197-198
- Available as an auxiliary frame with no controller or pump. Order mounting stand, load frame selector valve and overload protection separately
- **Mounting stand: OPTIONAL**, order: HCM-0032

Specification	Value
Vertical Opening	18.5" (470mm)
Horizontal Opening	9.250" (235mm)
Piston Stroke	2.125" (54mm)
Lower Platen, Dia.	NA
Upper Platen, Dia.	NA
Oil Reservoir Cap.	2 gal (7.6 liter)
Overall Width	28.625" (727mm)
Overall Depth	16" (406mm)
Overall Height	51.50" (1308mm)

See Page 195-196 for models and ordering information.

**HCM-0030 Series Compression Machines**

CE Ship wt. 460 lbs. (208kg)

**HCM-1000 Series Compression Machines**

ASTM C39, E4, AASHTO T22

The HCM-1000 has been custom-configured to be used for mortar applications like 2" and 4" cubes, beams and other low-strength materials, below 100,000 lbs. (445kN). These machines are based on HCM-2500 frames, which have been reconfigured for accurate readings of lower-strength materials. The machines are sold without platens, so be sure to order the appropriate set for your applications.

- Custom-configured for mortar applications like 2" and 4" cubes
- 1,000 to 100,000 (11 to 445kN) testing range with accuracy of  $\pm 0.5\%$  of indicated load
- Choice of two digital controllers and two digital indicators (see page 187-189)
- Machine comes with no platens, order the appropriate set for your applications
- **Mounting stand: OPTIONAL**, order: HCM-0200

Specification	Value
Vertical Opening	19.375" (492mm)
Horizontal Opening	9.25" (235mm)
Piston Stroke	2.5" (63.5mm)
Lower Platen	NA
Upper Platen, Dia.	NA
Oil Reservoir Cap.	2 gal (7.6 liter)
Overall Width	30" (762mm)
Overall Depth	23.750" (603mm)
Overall Height	60.625" (1540mm)

See Page 195-196 for models and ordering information

**HCM-1000 Series Compression Machines**

CE Ship wt. 655lbs. (297kg)

CONCRETE

**HCM-2500 Series Compression Machines**

ASTM C39, E4, AASHTO T22

- Suitable for cylinders, cubes, beams and cores of standard strength concrete mixes
- 500 to 250,000 lbf (11 to 1112kN) testing range with accuracy of  $\pm 0.5\%$  of indicated load
- Suitable for concrete strength up to 7,000 psi for 6" diameter cylinders
- Standard configuration includes platens to test 6" x 12" (150mm x 300mm) cylinders.
- Choice of two digital controllers or two digital indicators (see page 187-189)
- Optional test platens and accessories available on pages 197-198
- Steel protective doors, not plastic.
- **Mounting stand: OPTIONAL**, order: HCM-0200

Specification	Value
Vertical Opening	19.375" (492mm)
Horizontal Opening	9.25" (235mm)
Piston Stroke	2.5" (63.5mm)
Lower Platen, Dia.	6.5" (165mm)Ø
Upper Platen, Dia.	6.5" (165mm)
Oil Reservoir Cap.	2 gal (7.6 liter)
Overall Width	27" (686mm)
Overall Depth	17" (432mm)
Overall Height	56.312" (1430mm)

See Page 195-196 for models and ordering information

**HCM-2500 Series Compression Machines**

CE Ship wt. 885 lbs. (401kg)



**NOTES**

Frame opening dimensions are measured without test platens installed in machine.  
Overall machine dimensions are measured with the stand, including machines where it is optional.





HCM-3000iH



HCM-4000iHA



HCM-5000iHP

**HCM-3000 Series Compression Machines**  
ASTM C39, E4, AASHTO T22

- Suitable for cylinders, cubes, beams and cores of standard strength concrete mixes
- 3000 to 300,000 lbf (13.3 to 1334kN) testing range with accuracy of  $\pm 0.5\%$  of indicated load
- Suitable for concrete strength up to 9,000 psi for 6" diameter cylinders
- Standard configuration includes platens to test 6" x 12" (150mm x 300mm) cylinders.
- Choice of two digital controllers and two digital indicators (see page 187-189)
- Optional test platens and accessories available on pages 197-198
- **Mounting stand: OPTIONAL**, order: HCM-0300

Specification	Value
Vertical Opening	18.5" (470mm)
Horizontal Opening	9.5" (241mm)
Piston Stroke	3" (76mm)
Lower Platen	9" x 12" (229 x 305mm)
Upper Platen, Dia.	6.5" (165mm)
Oil Reservoir Cap.	2 gal (7.6 liter)
Overall Width	31.5" (800mm)
Overall Depth	17" (432mm)
Overall Height	58.5" (1486mm)

See Page 195-196 for models and ordering information

**HCM-3000 Series Compression Machines**



Ship wt. 1078 lbs. (488kg)

**HCM-4000 Series Compression Machines**  
ASTM C39, E4, AASHTO T22

- Suitable for cylinders, cubes, beams and cores of high-strength concrete mixes
- 4000 to 400,000 lbf (17.8 to 1780kN) testing range with accuracy of  $\pm 0.5\%$  of indicated load
- Suitable for concrete strength up to 11,000 psi for 6" diameter cylinders
- Standard configuration includes platens to test 6" x 12" (150mm x 300mm) cylinders.
- Choice of two digital controllers and two digital indicators (see page 187-189)
- Optional test platens and accessories available on pages 197-198
- Large frame opening to allow easier loading of test specimens
- Mounting stand is **INCLUDED**

Specification	Value
Vertical Opening	18.375" (467mm)
Horizontal Opening	13.312" (338mm)
Piston Stroke	2.5" (63.5mm)
Lower Platen	12.5" x 18" (318 x 475mm)
Upper Platen, Dia.	6.5" (165mm)
Oil Reservoir Cap.	2 gal (7.6 liter)
Overall Width	39.875" (1013mm)
Overall Depth	20" (508mm)
Overall Height	61.250" (1556mm)

See Page 195-196 for models and ordering information

**HCM-4000 Series Compression Machines**



Ship wt. 1700 lbs. (771kg)

**HCM-5000 Series Compression Machines**  
ASTM C39, E4, AASHTO T22

- Suitable for cylinders, cubes, beams and cores of high-strength concrete mixes
- 5000 to 500,000 lbf (22.2 to 2224kN) testing range with accuracy of  $\pm 0.5\%$  of indicated load
- Suitable for concrete strength up to 14,000 psi for 6" diameter cylinders
- Standard configuration includes platens to test 6" x 12" (150mm X 300mm) cylinders.
- Choice of two digital controllers and two digital indicators (see page 187-189)
- Optional test platens and accessories available on pages 197-198
- Large frame opening to allow easier loading of test specimens
- Mounting stand is **INCLUDED**

Specification	Value
Vertical Opening	18.375" (467mm)
Horizontal Opening	14" (356mm)
Piston Stroke	2.5" (63.5mm)
Lower Platen	12.5" x 18" (318 x 475mm)
Upper Platen, Dia.	6.5" (165mm)
Oil Reservoir Cap.	2 gal (7.6 liter)
Overall Width	30" (762mm)
Overall Depth	23.750" (603mm)
Overall Height	60.625" (1540mm)

See Page 195-196 for models and ordering information

**HCM-5000 Series Compression Machines**



Ship wt. 2500 lbs. (1134kg)



**NOTES**

- Frame opening dimensions are measured without test platens installed in machine.
- Overall machine dimensions are measured with the stand, including machines where it is optional.







### High-Performance 3000 / 4000 / 5000 / 6000kN Computer-Controlled Compression Machines

ASTM C39, AASHTO T22; DIN EN 12390-3, 12504-1, 12390-6, EN 12390-13, EN 206

Compression testing machines for compressive strength testing of light, normal and heavy concrete, as well as ultra-high performance concrete (UHPC), according to DIN EN 7500-1 and EN 12390-4 in a very wide measuring range class 1.

- Extremely solid and stiff 4-column frame
- Large area test chamber protection made of polycarbonate, protects against specimen splinters caused by explosion fractures
- High-quality servo valve for pressure or volume flow control
- Powerful hydraulic unit
- Fast lift and bypass function for time-saving positioning of the test cylinder
- DOLI EDCi Control electronics fully-automatic test procedures suitable for force, displacement or deformation controlled tests with predefined loading speeds
- Automatic break detection and free adjustable test end conditions
- Readout and export of measurement data

#### Test frame

Test frame with hydraulic cylinder for compression strength test in strain gauged column according to DIN EN 12390-4 and class 1 according to DIN EN 7500-1 in the specified measuring range. In the basic configuration, the framework is designed for force-controlled tests, whereby the force value

is determined via a strain gauge pressure sensor. Optionally a position measuring system can be installed. The massive steel frame is extremely stiff, the columns are tensioned without any play. The hydraulic cylinder is made from solid material and is attached utilizing an external clamp holder. The end position is monitored by a mechanical limit switch.

**Samples:** Cubes (edge length): 200, 150, 100mm (auxiliary platens required) Cylinders (height) 320, 300, 200mm Devices (height) up to 330mm e.g. splitting tensile. Other samples possible.

**Safety:** The test frame with a control cabinet fulfills all requirements according to DIN EN 12390-4 and DIN EN ISO 7500-1.

The complete machine is delivered with an EC declaration of conformity and operating instructions according to the Machinery Directive 2006/42 / EG. Large area of the testing machine is equipped with an impact-resistant, transparent test room protection made of polycarbonate. The position of the protective door is monitored with a tamper-proof, 2-channel security hinge. When the door is open, the hydraulic unit is redundantly depressurized.

#### Control cabinet SV-EDCi

Control cabinet with main switch incl. under-voltage release and emergency stop switch, as well as a Schuko plug on the front panel. Electrical Connection: 1~240V, 50/60Hz, 3~480V, 50/60Hz.

#### Hydraulic system

The powerful hydraulic unit with oil tank incl. all necessary safety, control and directional valves according to DIN 4413. It generates a maximum

system pressure of 350 bar A fine 3µm pressure filter in the pressure line is filtering the hydraulic oil and protecting the system components. Incl. filter pollution, oil level and temp switch (70 ° C) The hydraulic unit is inside of the control cabinet providing low noise operation <68 dB (A). A high-quality servo valve or variable-frequency drive for pressure or volume flow control enables the most precise force and stroke control (closed-loop control). An additional low-pressure pump for the quick stroke function and an oil-air cooler (for long test scenarios).

#### Measuring and control electronics

A Doli EDCi controller is used for universal digital measuring and control electronics for these testing machines. This is installed in the control cabinet and can optionally be operated with a remote control. The control electronics enables a fully automatic test execution with given loading speeds for force-controlled tests (position and strain controlled tests optional). With sensitive and adjustable break detection, the failure of the sample is detected early. Communication to the PC: Ethernet socket / USB 2.0 configuration Remote maintenance via TeamViewer function (PC required).

#### Technical data EDCi

Expansion option: min. 2 channels

Supply voltage + 24 VDC, 1.5 A Control output ± 10V A / B pulse train to control the subsequent electronics Automatic sensor detection by intelligent sensor connector SGS Calibration data is saved in the sensor plugs.



Specification	HCM-3100	HCM-4100
Capacity	674,426 lbf. (3000kN)	899,235 lbf (4000kN)
Force measuring range, class 1	13488 - 674426 lbf (60 – 3000 kN)	17984- 899235 lbf (80 – 4000 kN)
Stroke	3.93" (100mm)	3.93" (100mm)
Chamber height	12.4" (315mm)	13.39" (340mm)
Column spacing front	14.17" (360mm)	17.72" (450mm)
Column spacing side	10.63" (270mm)	17.72" (450mm)
Platen dimensions	12.6" (Ø320mm)	16.34" (Ø415mm)
Frame Dimensions	29.5" x 26" x 62.2" 750 x 660 x 1580 mm	36.6" x 33.9" x 77.2" 930 x 860 x 1960 mm
Control Cabinet Dimensions	47.25" x 22.45" x 41" 1200 x 570 x 1040 mm	47.25" x 22.45" x 41" 1200 x 570 x 1040 mm

Specification	HCM-5100	HCM-6100
Capacity	1,124,044 lbf (5000kN)	1,348,854 lbf (6000kN)
Force measuring range, class 1	22481- 1,124,044 lbf (100 – 5000 kN)	26977 - 1,348,854 lbf (120 – 6000 kN)
Stroke	3.93" (100mm)	3.93" (100mm)
Chamber height	13.39" (340mm)	13.39" (340mm)
Column spacing front	17.72" (450mm)	21.85" (555mm)
Column spacing side	17.72" (450mm)	17.72" (450mm)
Platen dimensions	16.34" (Ø415mm)	16.34" (Ø415mm)
Frame Dimensions	39" x 36.2" x 79.1" 990 x 920 x 2010 mm	39.4" x 35.4" x 66.9" 1000 x 900 x 1700 mm
Control Cabinet Dimensions	47.25" x 22.45" x 41" 1200 x 570 x 1040 mm	47.25" x 22.45" x 41" 1200 x 570 x 1040 mm

**3000kN (674,426 lbs.) Compression Machines**

ASTM C39, AASHTO T22; DIN EN 12390-3, 12504-1, 12390-6, EN 12390-13, EN 206

Compression testing machines for compressive strength testing of light, normal and heavy concrete, as well as ultra-high performance concrete (UHPC), according to DIN EN 7500-1 and EN 12390-4.

**3000kN Compression Machine, Servo-controlled HCM-3100.7F**  
**3000kN Compression Machine, Variable Drive HCM-3101.7F**

CE Ship wt. 3640 lbs. (1650kg)

**4000kN (899,235 lbs.) Compression Machine, Servo-controlled**

ASTM C39, AASHTO T22; DIN EN 12390-3, 12504-1, 12390-6, EN 12390-13, EN 206

Compression testing machines for compressive strength testing of light, normal and heavy concrete, as well as ultra-high performance concrete (UHPC), according to DIN EN 7500-1 and EN 12390-4.

**4000kN Compression Machine, Servo-controlled HCM-4100.7F**

CE Ship wt. 8820 lbs. (4000kg)

**5000kN (1,124,044 lbs) Compression Machine**

ASTM C39, AASHTO T22; DIN EN 12390-3, 12504-1, 12390-6, EN 12390-13, EN 206

Compression testing machines for compressive strength testing of light, normal and heavy concrete, as well as ultra-high performance concrete (UHPC), according to DIN EN 7500-1 and EN 12390-4.

**5000kN Compression Machine, Servo-controlled HCM-5100.7F**

CE Ship wt. 11025 lbs. (5000kg)

**6000kN (1,348,853 lbs.) Compression Machine**

ASTM C39, AASHTO T22; DIN EN 12390-3, 12504-1, 12390-6, EN 12390-13, EN 206

Compression testing machines for compressive strength testing of light, normal and heavy concrete, as well as ultra-high performance concrete (UHPC), according to DIN EN 7500-1 and EN 12390-4.

**6000kN Compression Machine, Servo-controlled HCM-6100.7F**

CE Ship wt. 13230 lbs. (6000kg)

**Intermediate Cube Platen Set, 200 and 150mm**

DIN EN 12390-4

For cubes 200mm (7.87") and 150mm (5.9")- Includes (1) 210 x 210 x 50mm (8.26" x 8.26" x 1.97") and (1) 160 x 160 x 75mm (6.3" x 6.3" x 2.95"). To be place on lower machine platen, including sample centering hardened > 58 HRC flatness < 0,03mm roughness Ra 0,4 bis 3,2 µm contact surfaces are parallel < 0,05mm.

**Inter. Cube Platen Set, 200 and 150mm HCM-5100.5**

CE Ship wt. 14lbs. (6,3kg)

**Intermediate Cube Platen Set, 100mm**

DIN EN 12390-4

For testing cubes 100mm (3,93") (only in combination with 30,0700) hardened > 58 HRC flatness < 0,03mm roughness Ra 0,4 to 3,2 µm contact surfaces are parallel < 0,05mm.

**Inter. Cube Platen Set, 100mm HCM-5100.6**

CE Ship wt. 14lbs. (6,3kg)

**Tensile Splitting Device**

EN 1338

Convex pressure cutting Test chamber height adjustable from 70 up to 170mm. Diameter of pressure blades 75mm. Length of pressure blades 330mm. Including distance piece 50mm (w/d/h) 350x245x285 max. mm.

**Tensile Splitting Device HCM-5100.7**

CE Ship wt. 25lbs. (11,3kg)

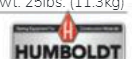



shown with optional Platen Carrier Bracket

HCM-5000PiHP

Draw rod is supplied with manually-controlled machines and must be ordered separately for automated machines.



HCM-0802

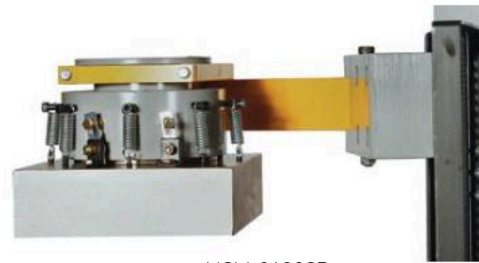

HCM-0190SP

**Masonry Series Compression Machines**

ASTM C39, C140, C1314, E4, AASHTO T22

Masonry series machines are available in a single capacity of 500,000 (2224kN) with a testing range from 1 to 100% of machine capacity, with an accuracy of ±0.5% of indicated load. These compression testing machines feature two-block masonry prism configuration of full-sized blocks up to 12" (304 mm) wide.

- Tests blocks, masonry prisms, pavers and retaining wall units
- 500,000 (2224kN) testing range with accuracy of ±0.5% of indicated load
- Machines up to 800,000 (3559kN) are also available, please inquire.
- Machines include platens for testing 6" x 12" (150 x 300mm) cylinders. Order appropriate platen set if 4" x 8" (100 x 200mm) cylinders testing is required.
- Draw rods are included with manually-operated machines. For automated machines the draw rod is ordered separately.

The heavy-duty load frames use the same proven design and manufacturing process found in all of our machines, with a wide horizontal opening and large compression platen table for easier loading of heavy specimens. The machine's included mounting stand also places the lower platen at a convenient working height.

These machines' unique lower, dual-platen system features a wear platen through-hardened to 60 HRC or greater and is designed for fast and easy maintenance without the need for expensive rental equipment to remove the platen, unlike the cumbersome single-plate systems used in competitive units.

Changing test platens and spacers can be quick, easy, and safe with our draw rod accessory, used to adjust the load frame's inside vertical working height, as well as the optional carrier bracket system, which features a heavy-duty arm mounted on the rear left corner of the load frame that pivots on two hinged joints. When the block platen is not being used, it can be conveniently stored on the bracket's arm. Includes mounting stand and limit switch.

Optional test platens and accessories add to the versatility of these prism machines, see pages 197-198. See Page 196 for models and ordering information.

**HCM-5000P Series Prism Machines**



Ship wt. 1,700 lbs. (771kg)

**Draw Rod Assembly**

Draw rods are included with all masonry model machines with manual controllers. For machines with HCM-5080 and HCM-5070 the Draw Rod Assembly must be ordered separately. The draw rod system is used to adjust the inside vertical working height of the load frame, to allow for testing samples of different heights through the use of spacers and test platens. The system is made up of a steel hand wheel with internal ball bearings and a threaded rod that is easily raised or lowered inside the load frame for height adjustment. Spacers slide onto the rod, the rod is threaded into the test platen and the assembly is then tightened against the cross-head.

**Draw Rod Assembly**

**HCM-0802**

Ship wt. 38 lbs. (17.3kg)

**Platen Carrier Brackets**

The Carrier Bracket is used for safer removal and mounting of the block platen assembly inside the load frame, and should be considered a must have option when testing masonry units.

The brackets heavy-duty arm is mounted on the rear left hand corner of the load frame and pivots on two hinged joints, allowing the complete assembly to rotate smoothly into and out of the load frame. When not in use, platen and arm are conveniently stored on rear of machine.

**HCM-4000 Carrier Bracket**

**HCM-0190SP**

Ship wt. 120 lbs. (54.4kg)

**HCM-5000 Carrier Bracket**

**HCM-0190P**

Ship wt. 155 lbs. (70.3kg)





### Concrete Compression Machine Ordering Matrix

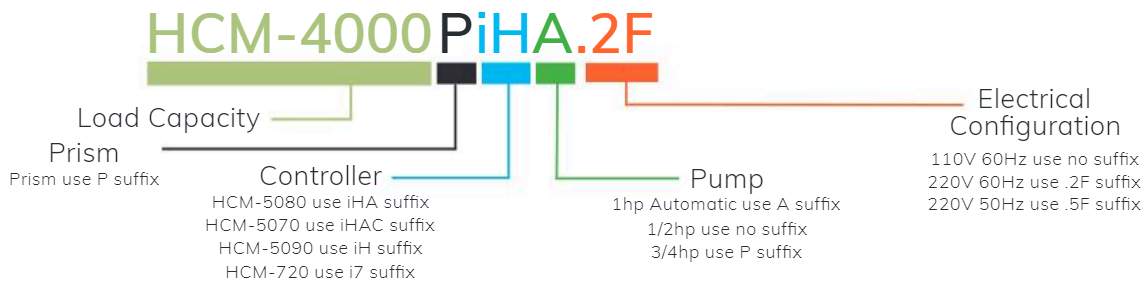

Concrete Compression Frame (ONLY)	
Compression Machine	Order Number
Compression Machine, 30,000 (133.5kN)	HCM-0030
Compression Machine, 100,000 (445kN)	HCM-1000
Compression Machine, 250,000 (1,112kN)	HCM-2500
Compression Machine, 300,000 (1,334kN)	HCM-3000
Compression Machine, 400,000 (1,780kN)	HCM-4000
Compression Machine, 500,000 (2,224kN)	HCM-5000
Compression Machine Prism Series, 500,000 (2,224kN)	HCM-5000P

**NOTES**  
 Frame only Compression machines does not include stand, order separately.

Compression Machine Capacities in PSI												
Load Capacity	Model	Cylinder			Cube			Brick	Beam		Block	
		3" x 6"	4" x 8"	6" x 12"	2"	6"	8"	2" x 4" x 8"	6"x 6"x 20"	4"x 4"x 14"	Single	Prism
30000	HCM-0030	3395	1910	849	6000	667	375	750	2222	3333	NA	NA
100000	HCM-1000	11318	6366	2829	20000	2222	1250	NA	7407	11111	NA	NA
250000	HCM-2500	28294	15915	7074	50000	5556	3125	6250	18519	27778	NA	NA
300000	HCM-3000	33953	19099	8488	60000	6667	3750	7500	22222	33333	NA	NA
400000	HCM-4000	45271	25465	11318	80000	8889	5000	10000	29630	44444	2500	2500
500000	HCM-5000	56588	31831	14147	NA	11111	6250	12500	37037	55556	3125	3125





## Concrete Compression Machine Ordering Matrix

HCM-0030 Series: 30,000 lbs. (133.5 kN)			
Controller	Pump Size	Electrical	Order Number
HCM-5090.3F	1/2hp Manual	120V 60Hz	HCM-0030iH
HCM-5090.3F	1/2hp Manual	230V 60Hz	HCM-0030iH.2F
HCM-5090.3F	1/2hp Manual	230V 50Hz	HCM-0030iH.5F
HCM-720	1/2hp Manual	120V 60Hz	HCM-0030i7
HCM-720	1/2hp Manual	230V 60Hz	HCM-0030i7.2F
HCM-720	1/2hp Manual	230V 50Hz	HCM-0030i7.5F

HCM-1000 Series: 100,000 lbs. (445 kN)			
Controller	Pump Size	Electrical	Order Number
HCM-5080	1hp Automatic	120V 60Hz	HCM-1000iHA
HCM-5080.4F		230V 50-60Hz	HCM-1000iHA.4F
HCM-5070		120V 60Hz	HCM-1000iHAC
HCM-5070.4F		230V 50-60Hz	HCM-1000iHAC.4F
HCM-5090.3F	1/2hp Manual	120V 60Hz	HCM-1000iH
HCM-5090.3F	1/2hp Manual	230V 60Hz	HCM-1000iH.2F
HCM-5090.3F	1/2hp Manual	230V 50Hz	HCM-1000iH.5F
HCM-720	1/2hp Manual	120V 60Hz	HCM-1000i7
HCM-720	1/2hp Manual	230V 60Hz	HCM-1000i7.2F
HCM-720	1/2hp Manual	230V 50Hz	HCM-1000i7.5F

HCM-2500 Series: 250,000 lbs. (1,112 kN)			
Controller	Pump Size	Electrical	Order Number
HCM-5080	1hp Automatic	120V 60Hz	HCM-2500iHA
HCM-5080.4F		230V 50-60Hz	HCM-2500iHA.4F
HCM-5070		120V 60Hz	HCM-2500iHAC
HCM-5070.4F		230V 50-60Hz	HCM-2500iHAC.4F
HCM-5090.3F	1/2hp Manual	120V 60Hz	HCM-2500iH
HCM-5090.3F	3/4hp Manual		HCM-2500iHP
HCM-5090.3F	1/2hp Manual	230V 60Hz	HCM-2500iH.2F
HCM-5090.3F	3/4hp Manual		HCM-2500iHP.2F
HCM-5090.3F	1/2hp Manual	230V 50Hz	HCM-2500iH.5F
HCM-5090.3F	3/4hp Manual		HCM-2500iHP.5F
HCM-720	1/2hp Manual	120V 60Hz	HCM-2500i7
HCM-720	3/4hp Manual		HCM-2500i7P
HCM-720	1/2hp Manual	230V 60Hz	HCM-2500i7.2F
HCM-720	3/4hp Manual		HCM-2500i7P.2F
HCM-720	1/2hp Manual	230V 50Hz	HCM-2500i7.5F
HCM-720	3/4hp Manual		HCM-2500i7P.5F

HCM-3000 Series: 300,000 lbs. (1,334 kN)			
Controller	Pump Size	Electrical	Order Number
HCM-5080	1hp Automatic	120V 60Hz	HCM-3000iHA
HCM-5080.4F		230V 50-60Hz	HCM-3000iHA.4F
HCM-5070		120V 60Hz	HCM-3000iHAC
HCM-5070.4F		230V 50-60Hz	HCM-3000iHAC.4F
HCM-5090.3F	1/2hp Manual	120V 60Hz	HCM-3000iH
HCM-5090.3F	3/4hp Manual		HCM-3000iHP
HCM-5090.3F	1/2hp Manual	230V 60Hz	HCM-3000iH.2F
HCM-5090.3F	3/4hp Manual		HCM-3000iHP.2F
HCM-5090.3F	1/2hp Manual	230V 50Hz	HCM-3000iH.5F
HCM-5090.3F	3/4hp Manual		HCM-3000iHP.5F
HCM-720	1/2hp Manual	120V 60Hz	HCM-3000i7
HCM-720	3/4hp Manual		HCM-3000i7P
HCM-720	1/2hp Manual	230V 60Hz	HCM-3000i7.2F
HCM-720	3/4hp Manual		HCM-3000i7P.2F
HCM-720	1/2hp Manual	230V 50Hz	HCM-3000i7.5F
HCM-720	3/4hp Manual		HCM-3000i7P.5F

HCM-4000 Series: 400,000 lbs. (1,780 kN)			
Controller	Pump Size	Electrical	Order Number
HCM-5080	1hp Automatic	120V 60Hz	HCM-4000iHA
HCM-5080.4F		230V 50-60Hz	HCM-4000iHA.4F
HCM-5070		120V 60Hz	HCM-4000iHAC
HCM-5070.4F		230V 50-60Hz	HCM-4000iHAC.4F
HCM-5090.3F	3/4hp Manual	120V 60Hz	HCM-4000iHP
HCM-5090.3F	3/4hp Manual	230V 60Hz	HCM-4000iHP.2F
HCM-5090.3F	3/4hp Manual	230V 50Hz	HCM-4000iHP.5F
HCM-720	3/4hp Manual	120V 60Hz	HCM-4000i7P
HCM-720	3/4hp Manual	230V 60Hz	HCM-4000i7P.2F
HCM-720	3/4hp Manual	230V 50Hz	HCM-4000i7P.5F

HCM-5000 Series: 500,000 lbs. (2,224 kN)			
Controller	Pump Size	Electrical	Order Number
HCM-5080	1hp Automatic	120V 60Hz	HCM-5000iHA
HCM-5080.4F		230V 50-60Hz	HCM-5000iHA.4F
HCM-5070		120V 60Hz	HCM-5000iHAC
HCM-5070.4F		230V 50-60Hz	HCM-5000iHAC.4F
HCM-5090.3F	3/4hp Manual	120V 60Hz	HCM-5000iHP
HCM-5090.3F	3/4hp Manual	230V 60Hz	HCM-5000iHP.2F
HCM-5090.3F	3/4hp Manual	230V 50Hz	HCM-5000iHP.5F
HCM-720	3/4hp Manual	120V 60Hz	HCM-5000i7P
HCM-720	3/4hp Manual	230V 60Hz	HCM-5000i7P.2F
HCM-720	3/4hp Manual	230V 50Hz	HCM-5000i7P.5F

HCM-5000P Masonry Prism Series: 500,000 lbs. (2,224 kN)			
Controller	Pump Size	Electrical	Order Number
HCM-5080	1hp Automatic	120V 60Hz	HCM-5000PiHA
HCM-5080.4F		230V 50-60Hz	HCM-5000PiHA.4F
HCM-5070		120V 60Hz	HCM-5000PiHAC
HCM-5070.4F		230V 50-60Hz	HCM-5000PiHAC.4F
HCM-5090.3F	3/4hp Manual	120V 60Hz	HCM-5000PiHP
HCM-5090.3F	3/4hp Manual	230V 60Hz	HCM-5000PiHP.2F
HCM-5090.3F	3/4hp Manual	230V 50Hz	HCM-5000PiHP.5F
HCM-720	3/4hp Manual	120V 60Hz	HCM-5000Pi7P
HCM-720	3/4hp Manual	230V 60Hz	HCM-5000Pi7P.2F
HCM-720	3/4hp Manual	230V 50Hz	HCM-5000Pi7P.5F



**Compression Machine Travel Limit Switch**  
An electrical switch that prevents the hydraulic piston from going beyond its maximum travel point.

Limit Switch, HCM-2500 Series  
Limit Switch, HCM-3000 Series  
Limit Switch, HCM-4000 Series  
Limit Switch, HCM-5000 Series

HCM-TM0101  
HCM-TM0106  
HCM-TM0100  
HCM-TM0102

Ship wt. 3 lbs. (1.4kg)



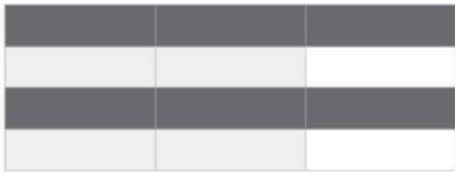

63

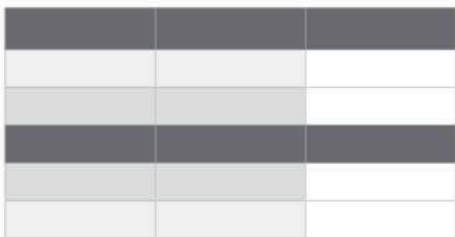

64  
65  
66

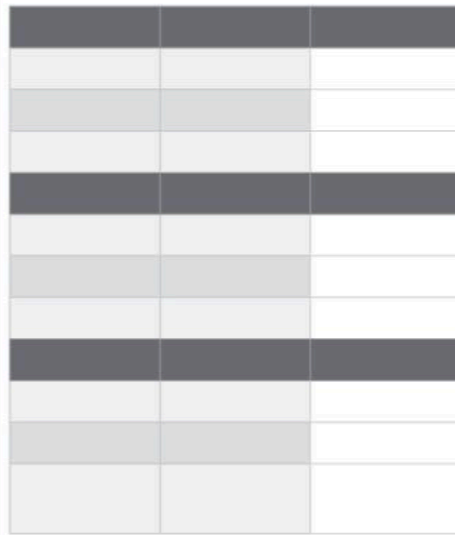

67

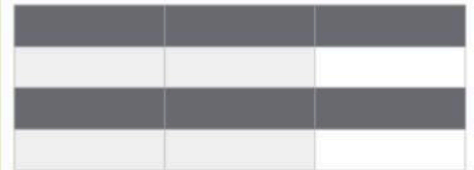

68

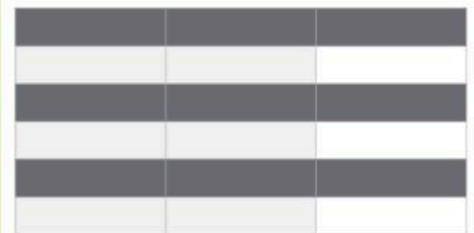

69

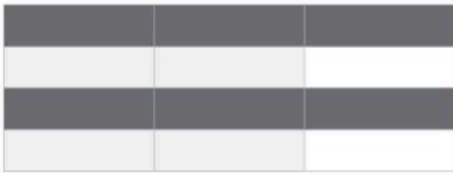
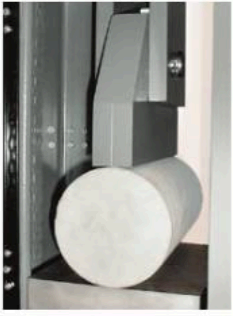

00000

00000

00

00000

00

00

00

00

00

00







\_\_\_\_\_

\_\_\_\_\_

\_\_\_\_\_

\_\_\_\_\_

\_\_\_\_\_











- \_\_\_\_\_
- \_\_\_\_\_
- \_\_\_\_\_
- \_\_\_\_\_
- \_\_\_\_\_







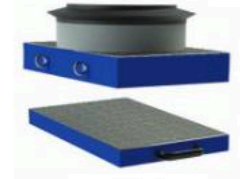

☰

---

☰

---

☰

---

☰

---

☰

---

☰

---

☰

---

☰

---

☰

---

☰

---

☰

---

☰

---

☰

---

☰

---

☰

---

☰

---







\_\_\_\_\_

\_\_\_\_\_

\_\_\_\_\_

\_\_\_\_\_

\_\_\_\_\_

\_\_\_\_\_















Table 1	

63

64

65

66

67

Table 2	





☒

☒

☒

☒

☒

☒

Header	



Table with 2 columns and 15 rows. The first column is shaded gray. The second column is white.

Table with 2 columns and 15 rows. The first column is shaded gray. The second column is white.

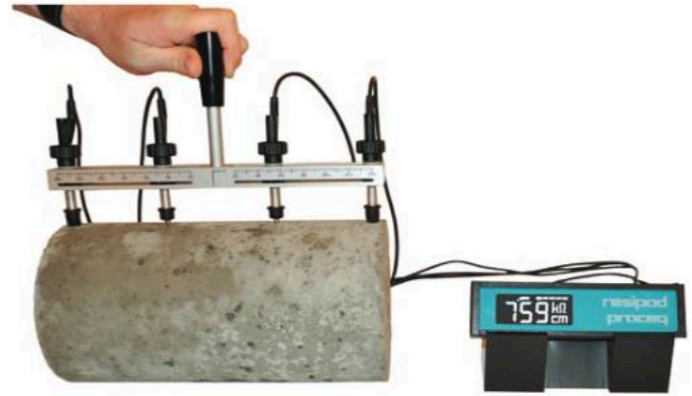

Table with 2 columns and 15 rows. The first column is shaded gray. The second column is white.





Header Row	

Header Row	







---

---





§

§

§











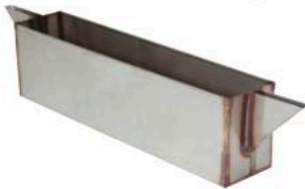



6

---

6

---

6

---

6

---

6

---

6

---

6

---



6

---



15

CE 0005

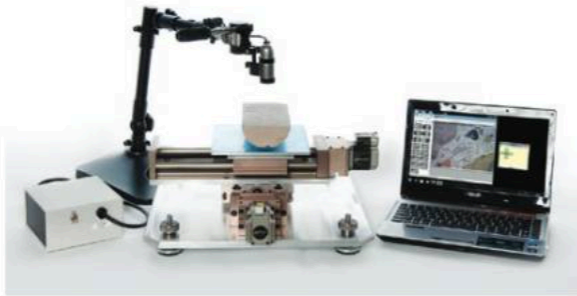
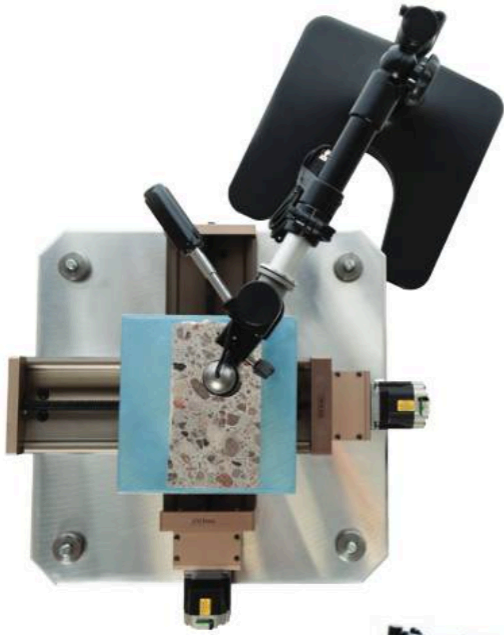

Table with 2 columns and 8 rows.	



13

14

15

16

17

18

19

20

21

22

23

24



HC-2941



HC-2947



HC-2948



HC-2955



HC-2956



HC-2955.1



HC-2950

**Professional, Digital Crack Monitoring Kit**

This set contains all that is needed to set up a crack monitoring system using precision calipers. This kit includes a crack width gauge to measure the width of cracks prior to monitoring, a digital caliper with data port, a pack of stainless steel discs, a pack of caliper marks, a pair of corner discs and crack record sheets. Also included is an illustrated manual with full instructions, which describes best practice methods for using the calipers. All the components can be re-ordered separately in order to replenish the kit.

**Pro, Digital Crack Monitoring Kit HC-2948**

Ship wt. 4lb. (1.8kg)

**Concrete Crack Data Logger**

The HC-2955 crack data logger provides a method to monitor cracks and linear displacements in concrete structures, featuring an integrated data logger, which measures both displacement and ambient temperature. This crack detector measures cracks, with a resolution of 0.01mm, by using a rotary, precision potentiometer, which is driven by the winding/unwinding of a stainless steel wire with an 80mm stroke. It is also possible to add an extension to the steel cable to monitor cracks over wide expanses or areas that are not readily accessible, such as bridge decks, multi-faceted structures and other hard-to-reach places. The crack detector is configured using a graphic, user interface operating on a Windows® computer.

Temperature measurement range is -4°F to 176°F (-20°C - +80°C) with 1° resolution. The unit is powered by a user-replaceable battery, which should last between six months and five years, depending on how the unit is configured and frequency of downloads.

The measurements are stored in internal mem-

ory and are downloaded to a Windows PC using a USB cable (supplied). Data logger capacity is: 51062 readings or 18236 readings with redundant CRC. Acquisition frequency is adjustable from 10 seconds to 91 hours. Includes a download link for the latest version of the user guide and software.

**Concrete Crack Data Logger HC-2955**

Ship wt. 1lb. (.45kg)

**Concrete Crack Data Logger, Wi-Fi**

The HC-2956 wireless crack data logger provides a method to monitor cracks and linear displacements in concrete structures, featuring an integrated data logger, which measures both displacement and ambient temperature. This crack detector measures cracks, with a resolution of 0.01mm, by using a rotary, precision potentiometer, which is driven by the winding/unwinding of a stainless steel wire with an 80mm stroke. It is also possible to add an extension to the steel cable to monitor cracks over wide expanses or areas that are not readily accessible, such as bridge decks, multi-faceted structures and other hard-to-reach places. The crack detector is configured using a graphic, user interface operating on a Windows® computer.

Temperature measurement range is -4°F to 176°F (-20°C - +80°C) with 1° resolution. The unit is powered by a user-replaceable battery, which should last between six months and five years, depending on how the unit is configured and frequency of downloads.

Measurements are stored in internal memory, which can be downloaded to a Windows PC via a wireless connection from a range of up to 150m using a graphic user interface on a PC computer. Data logger capacity is: 51062 readings or 18236 readings with redundant CRC. Acquisition fre-

quency is adjustable from 10 seconds to 91 hours. Includes a download link for the latest version of the user guide and software.

**Concrete Crack Data Logger HC-2956**

Ship wt. 1lb. (.45kg)

**Extension Cables for Concrete Crack Data Loggers**

Extension kit for the HC-2955 and HC-2956 Concrete Crack Data Loggers for those applications requiring a longer span across larger cracks and joints or where mounting points require a longer expanse. These cables are available in 4 sizes: 12" (30cm); 20" (50cm); 39" (100cm) and 79" (200cm).

**Cable Extension, 12" (30cm) HC-2955.1**

**Cable Extension, 20" (50cm) HC-2955.2**

**Cable Extension, 39" (100cm) HC-2955.3**

**Cable Extension, 79" (200cm) HC-2955.4**

Ship wt. 1lb. (.45kg)

**Concrete Crack Measuring Microscope**

The crack measuring microscope is a precision, hand-made product, which is designed specifically for measuring cracks in concrete. This high-definition microscope is further enhanced by having its own adjustable light source for darkened conditions. Overall height of the microscope is 5.125" (130mm).

The image is focused by turning a knurled knob on the side of the instrument and the eyepiece scale can be rotated through 360° to align with the direction of the crack. The 4mm width of measurement has a lower scale, divided into 0.2mm divisions, which are subdivided into 0.02mm divisions. Comes complete in its own sturdy wooden pocket-size case.

**Concrete Crack Measuring Microscope HC-2950**

Ship wt. 2lb. (0.9kg)







HC-3000



HC-3001



HC-3000.1  
HC-3000.6  
HC-3000.7



HC-3000.2

HC-3000.2C



HC-3000.11

HC-3000.3



HC-3000.4  
HC-3000.5



HC-3000.10

HC-3000.9



HC-3000.8

**RH/Moisture Meter Kit with BluePeg Sensor**  
ASTM F2170

The HC-3000 concrete moisture meter for contractors, floor covering installers and restoration specialists to use as a Thermo-Hygrometer or for in-depth moisture testing of concrete following ASTM F2170-11 RH in-situ probe test. Moisture meter indicates relative humidity, temperature, GPP and DPT.

If you are looking for an accurate Hygrometer, the HC-3000 concrete moisture meter with RH BluePeg probe should be your choice. The RH BluePeg probe uses a hi-accuracy sensor with a short acclimation time. The RH BluePeg probe can be connected with a small Adapter directly to the meter. For extended reach, a cable up to 50ft long can be added. All cables have easy-to-connect and fail-proof 35mm stereo connectors.

The RH BluePeg Probe, sleeves, cable and RH concrete moisture meter have been designed for a simple and fail-proof measuring procedure.

The RH BluePeg probe drops easily into the sleeve. The cap fits perfectly and is as flat as can be. The 3.5mm stereo connector can be easily connected. No pin alignment of the cable needs to be fitted. Plug in and read, that's what our customers like.

**RH Moisture Meter w/BluePeg Sensors HC-3000**

Ship wt 2.9lbs. (1.3kg)

**BW/Moisture Non-Invasive Meter Kit with BluePeg Sensor**  
ASTM F2170, F2659

The HC-3001 is a non-invasive moisture meter with dual-depth measuring capabilities. The RH BluePeg Probe can be added to use as a Thermo-Hygrometer or for RH in-situ probe testing of concrete following the latest ASTM F2170 standard. The HC-3001's unique dual-depth pinless moisture meters allows the user to have more versatility. Two moisture meters in one. Great for thinner and thicker boards, engineered floor planks, and waterborne finishes.

Wood in Scan Mode: the HC-3001 gives wood moisture readings in percent. Corrections are built-in for a measuring depth of 1/4" and for 3/4" for each wood species setting (specific gravity 0.3 to 1.0). Included are 7 different settings for bamboo.

Building Materials in Scan Mode: the HC-3001 gives moisture content in percent for drywall. For concrete and light-weight building materials comparative readings can be taken to evaluate moisture conditions and find wet spots. 1/4" and 3/4" measuring depth are available. Conforms to ASTM 2659.

Air in RH Mode: Add RH BluePeg Probe for ambient relative humidity and temperature, GPP and DPT. Use meter as Thermo-Hygrometer.

Concrete in RH Mode: Add RH BluePeg Probes and RH accessories for in-situ moisture testing of concrete. Conforms to ASTM F2170.

**BW Moisture Non-Invasive Meter w/BluePeg Sensors**

HC-3001

Ship wt 5lbs. (2.26kg)

HC-3000 & HC-3001 Moisture Meter Accessories	
Blue-Peg Sensors, 5-pk.	HC-3000.1
Blue-Peg Sensors, 10-pk.	HC-3000.7
Blue-Peg Sensors, 1-pk.	HC-3000.6
RH Cable	HC-3000.2
RH Cable for In-Situ Concrete	HC-3000.2C
RH Adapter for Sleeves	HC-3000.3
RH Adapter for Meter	HC-3000.11
Sleeves, 20-pk., 1.8"	HC-3000.4
Sleeves, 100-pk., 1.8"	HC-3000.5
Sleeves, 10-pk., 3.0"	HC-3000.10
Calibration Salt	HC-3000.9
Brush	HC-3000.8





HC-2994



HC-2995A



HC-2990



HC-2993B



HC-2994.4



HC-2994.7



HC-2994.2



HC-2994.9



HC-2994.8

**Concrete Moisture Meter**

ASTM F2659, F2170, F2420, BS 5325 and BS 8293 Tramex CMEX II is a digital display version of the concrete encounter. It operates on the principle of non-destructive impedance measurement. Parallel co-planar electrodes are mounted on the base, which during operation transmit a low-frequency signal into a concrete slab. Quickly and easily measures moisture content. Can be used with the Hygro-i relative humidity probe, which when connected, changes the moisture meter into hygrometer mode. This combination provides an ideal solution for measurements of ambient relative humidity, temperature and dew-point conditions within a building structure, especially concrete flooring. Humidity readings are displayed in both % relative humidity and mixing ratio (grains/lb or grams/kg). Provides accurate and fast results allowing concrete slab testing per ASTM F2170 in-situ method, and ASTM F2420 RH hood method.

**Concrete Moisture Meter**

**HC-2994**

Ship wt 3lbs. (1.6kg)

**Concrete Inspection Kit**

ASTM F2659, F2170

A complete kit for testing concrete moisture per ASTM F2659 & ASTM F2170, featuring the HC-2994 moisture meter and Hygro-i® relative humidity probes. The Concrete Inspection Kit includes:

- CMEX II Digital, concrete moisture meter.
- 4 Hygro-i® RH probes for testing to ASTM F2170.
- Hygro-i® Electronic Interface Cable
- 12 Hole liners for testing to ASTM F2170.
- Calibration check salts for RH probes.
- IRTX Infrared surface thermometer and heavy-duty carry case.

**Features:**

- Instant, non-destructive concrete moisture content test from 0 - 6.9% to ASTM F2659.
- Fastest, most reliable Hygro-i® RH probe for testing to ASTM F2170.
- Perform multiple tests simultaneously.
- Re-usable Hygro-i® Relative Humidity probes prove to be the lowest cost per ASTM F2170.
- Test ambient site conditions of Temperature, RH, Dew Point & Mixing Ratio.
- Backlit display for ease of reading in low level lighting.
- Check calibration of RH probes as often as required by standards.
- Instant surface temperature readings to avoid condensation.

**Concrete Moisture Meter**

**HC-2995A**

Ship wt 9lbs. (4.1kg)

**Relative Humidity, Hygro-i Probe**

ASTM F2170, F2420, BS 5325 and BS 8203

Relative humidity probe for use with HC-2994 concrete moisture meter.

**Relative Humidity Hygro-i Probe**

**HC-2994.5**

Ship wt 2lbs. (.9kg)

HC-2994 Moisture Meter Accessories	
Hygro-i® Probe, 1 Probe	HC-2994.1
Hygro-i® Probe, 3-pk.	HC-2994.2
Hygro-i® Probe, 6-pk.	HC-2994.3
Hygro-i® Probe, 12-pk.	HC-2994.6
Hygro-i® Interface Cable	HC-2994.4
Insulated RH Hood	HC-2994.7
Calibration Check	HC-2994.8
Calibration Check Plate	HC-2994.9
Hole Liners, 50-pk.	HC-2994.10
Hole Liners, 100-pk.	HC-2994.11

**Concrete Encounter (Moisture)**

The concrete encounter is a hand-held electronic moisture meter, which uses non-destructive impedance measurement to determine moisture levels in concrete floors. The concrete encounter will give you an instant reading of moisture content to over 6% for concrete and 0-10 comparative for gypsum floor screeds, enabling you to make an informed decision on when to install floor coverings. Designed to be used on clean, dust-free slabs, just switch on and press the instrument firmly against the floor surface. Readings are then read directly from the analog meter. Coplanar electrodes with spring-loaded contacts enhance signal depth and sensitivity to a depth of .5" (12.5mm).

**Concrete Encounter (Moisture)**

**HC-2990**

Ship wt 1.4lbs. (0.6kg)

**Vapor Emission Test Kit**

ASTM E1907, F1869

The vapor emission test is used for determining the moisture acceptability for the placement of floor coverings and coatings over concrete slab surfaces. Using this method, users can easily quantify the volume of water vapor emitting from a 1,000 square foot concrete slab over a 24-hour period. Commonly known as the anhydrous calcium chloride vapor emission method, the test is directly specified by the vast majority of the floor covering industry as the primary measure of moisture acceptability for floor covering or coating installations. The kit consists of a calcium chloride container, a specifically designed dome cover with seal and step-by-step instructions. A balance or scale readable to 0.1 grams is required, but must be purchased separately.

**Vapor Emission Test Kit**

**12-pack (10,000 sq. ft. coverage)**

**HC-2993B**

**3-pack (1,000 sq. ft. coverage)**

**HC-2993A**

Ship wt 4.4lbs. (1.9kg)



